

LibrePCB Documentation

2024-03-28

Table of Contents

Installation	2
Official Binaries	2
Distribution Packages	2
Build From Sources	2
On Windows	2
Online Installer	2
Portable Package	3
On Linux	3
Portable AppImage (x86_64)	3
Snap Package (multi-arch)	3
Flatpak (multi-arch)	4
Online Installer (abandoned)	4
On macOS	4
Portable Package	4
Online Installer (abandoned)	5
Build From Sources	5
Requirements	5
Get the Sources	5
Build LibrePCB	6
Additional Resources	6
Quickstart Tutorial	7
Create a Workspace	7
Install Remote Libraries	9
Create a Local Library	11
Create a PCB Project	13
Create Schematics	16
Create Board	19
Order PCB	28
Create Library Elements	32
Concept Overview	33
Our Example: LMV321LILT	34
Component Category	35
Symbol	36
Component	41
Package Category	46
Package	47
Device	53
User Manual	55

Layers	55
Schematic Layers	55
Board Layers	56
Custom Layers	59
Licenses	59
Available Licenses	59
Other Licenses	60
Additional Actions	61
Recommendation	61
License of Libraries	61
Project Editor	61
Assembly Data	61
Output Jobs	70
Command-Line Interface	87
Installation	87
Binary Releases	87
Docker Image	88
Show Help Text	88
Command "open-library"	88
Examples	89
Command "open-project"	90
Examples	92
Library Conventions	94
Symbol Conventions	94
Generic vs. Specific	94
Naming	94
Origin	95
Outline	95
Pin Placement	96
Pin Naming	96
Text Elements	96
Grab Area	97
Package Conventions	97
Scope	97
Naming	98
Pads	98
Footprints	99
Origin	100
Orientation	101
Legend Layer	101
Documentation Layer	102

Package Outlines Layer	103
Courtyard Layer	103
Text Elements	104
3D Models	106
Development	107

Welcome to the documentation of LibrePCB 1.0.0!



The documentation is still work in progress. Help us writing beautiful documentation [on GitHub!](#)



Video Tutorials

In addition to this documentation in written form, there are also [video tutorials](#) available on our [YouTube channel](#).



Offline Documentation

For offline- or printable documentation, use the PDF download link at the bottom left of the page.

Chapters:

- [Installation](#)
- [Quickstart Tutorial](#)
- [User Manual](#)
- [CLI Reference](#)
- [Library Conventions](#)
- [Development](#)

Didn't find what you're looking for? [Contact us!](#)

Installation

Official Binaries

We provide official binary releases for the following operating systems:

- [Windows](#)
- [Linux](#)
- [macOS](#)

Distribution Packages

In addition, we are officially maintaining the following packages:

- [Snap on Snapcraft](#)
- [Flatpak on Flathub](#)

For other systems, a LibrePCB package might be provided by a package maintainer, either partially related or unrelated to the LibrePCB developers. We are aware of the following packages:

- [Arch Linux AUR Package](#) (builds from source)
- [NixOS Package](#)
- [Gentoo Package](#)
- [Homebrew Cask Package](#)
- [OpenPandora Package](#)
- [Void Linux Package](#)



You're a LibrePCB package maintainer? [Ask us](#) to list your package here!

Build From Sources

Since LibrePCB is a free & open-source application, you can compile it by yourself if you like. This allows to run LibrePCB even on systems where no pre-built binaries are available. See instructions at [Build From Sources](#).

On Windows

Online Installer

The recommended way to install LibrePCB is to use the online installer. It provides the following features:

- Installs a maintenance tool to easily download and install updates.

- Creates start menu entries for LibrePCB and the maintenance tool.
- Optionally registers *.lpp files, so LibrePCB projects can be opened with a double-click in the file manager.

Just download and run [librepcb-installer-1.0.0-windows-x86.exe](#). Afterwards you'll find LibrePCB in your start menu.

Portable Package

Alternatively you could run LibrePCB without installing it. But then you don't get an update mechanism, no start menu entries are created, and *.lpp files will not be registered.

Download and extract [librepcb-1.0.0-windows-x86.zip](#), then run the contained file `bin\librepcb.exe`.

On Linux

Due to the diversity of the Linux ecosystem, there are many different ways to install LibrePCB. The order of the options provided below do not reflect any recommendation.



If you're unsure, here our recommendations:

- On Ubuntu: [Snap Package](#)
- On a Raspberry Pi: [Flatpak](#)
- Everywhere else: [Portable AppImage](#)

Portable AppImage (x86_64)

The AppImage is a single-file portable package which runs on most Linux distributions. It is fully functional without installing anything on your system, but it does not provide an update mechanism.

Download [librepcb-1.0.0-linux-x86_64.AppImage](#), make it executable and run it:

```
wget "https://download.librepcb.org/releases/1.0.0/librepcb-1.0.0-linux-x86_64.AppImage"
chmod +x ./librepcb-1.0.0-linux-x86_64.AppImage
./librepcb-1.0.0-linux-x86_64.AppImage
```

If you're not familiar with the terminal: Right-click on the downloaded file and then check something like *Allow executing file as program* or *Run as executable*. Afterwards double-click the file to run it.

Snap Package (multi-arch)

For distributions like Ubuntu which use the [Snap](#) package manager, probably the easiest way is to install the [LibrePCB Snap package](#).

On Ubuntu, just open the *Ubuntu Software* application (app store), search for LibrePCB and install it. Alternatively, run this command from in the terminal:

```
sudo snap install librepcb
```

Some users [reported](#) that LibrePCB crashes when installed as a Snap package. It seems to be a problem related to fonts and Snap. If you experience this issue, the following workaround might help:



```
sudo rm /var/cache/fontconfig/*
rm ~/.cache/fontconfig/*
fc-cache -r
```

For more information about Snap, check out [its documentation](#).

Flatpak (multi-arch)

LibrePCB is also available as a [Flatpak](#) package from [Flathub](#). Assuming you have followed the [Flatpak setup](#) steps, you can configure Flathub and install LibrePCB as follows:



After installing Flatpak itself, make sure to **reboot the computer** before executing the following commands! Otherwise LibrePCB might not appear in your application launcher.

```
flatpak remote-add --if-not-exists flathub
https://flathub.org/repo/flathub.flatpakrepo
flatpak install flathub org.librepcb.LibrePCB
```

Online Installer (abandoned)

Note that starting with LibrePCB 1.0, we do no longer provide an installer for Linux. If you installed a previous LibrePCB release with the installer, please uninstall it with the *LibrePCB Maintenance Tool* and install the latest release with a different installation method instead.

On macOS

Portable Package

To install LibrePCB, download the portable [*.dmg](#) file matching your CPU architecture:

- **Intel (x86_64):** [librepcb-1.0.0-mac-x86_64.dmg](#)
- **Apple Silicon (arm64):** [librepcb-1.0.0-mac-arm64.dmg](#)

Double-click the downloaded file in Finder. Then drag and drop the LibrePCB app onto the

"Applications" folder in Finder. Afterwards you'll find LibrePCB in the Launchpad.



Unfortunately we're not able (yet) to officially sign the macOS binary. Therefore macOS refuses to start LibrePCB by default. As a workaround, you need to run it once with **Right-click > Open** on the LibrePCB application in the Launchpad. If this doesn't work, try it a second time.

Afterwards you should be able to run LibrePCB normally with a single click.

Online Installer (abandoned)

Note that starting with LibrePCB 1.0, we do no longer provide an installer for macOS. If you installed a previous LibrePCB release with the installer, please uninstall it with the *LibrePCB Maintenance Tool* and install the latest release with the [Portable Package](#) instead.

Build From Sources

Requirements

To compile LibrePCB, you need to install the following tools & libraries first:

- `g++` ≥ 4.8 , MinGW ≥ 4.8 , or Clang ≥ 3.3 (C++11 support is required)
- `Qt` ≥ 5.5
- [OpenCASCADE](#) OCCT or OCE (optional)
- [OpenGL Utility Library](#) GLU (optional)
- `zlib`
- [OpenSSL](#)
- `CMake` 3.5 or newer

Get the Sources

It is very important to use the correct sources:



- **Do NOT clone any branch (e.g. `master`) from our repository on GitHub!** These sources are not compatible with the stable file format of LibrePCB.
- Do NOT use the archives provided at the GitHub Releases page. These do not include the submodules and thus can't be compiled.
- It's fine to clone the official release **tag** (current: `1.0.0`) from our repository on GitHub, just keep in mind to pass `--recursive` to also get all the submodules.

For convenience, we provide an official source archive which contains all the required files (including submodules) and has stripped any unnecessary files: [librepcb-1.0.0-source.zip](#)

```
wget "https://download.librepcb.org/releases/1.0.0/librepcb-1.0.0-source.zip"
```

```
unzip ./librepcb-1.0.0-source.zip
cd ./librepcb-1.0.0
```

Build LibrePCB

Within the downloaded source directory, execute the following commands:

```
mkdir build && cd build
cmake ..
make -j8
```

Additional Resources

These are just the most important commands. For more details (e.g. the available configuration flags), check out the following resources:

- [README.md](#) within the source archive
- [Build instructions](#) on our developers documentation

Quickstart Tutorial

This chapter provides a quick introduction into LibrePCB, starting from workspace initialization and ending with how to order the designed PCB.

Create a Workspace

When starting LibrePCB the first time, a wizard asks you to open or create a workspace. The workspace is just a directory where settings, libraries and (optionally) projects will be stored. Once created, it can be used from all supported operating systems (i.e. it is platform independent) and from any LibrePCB version.

You can just accept the default workspace location (you could still move it to another location afterwards, if desired):

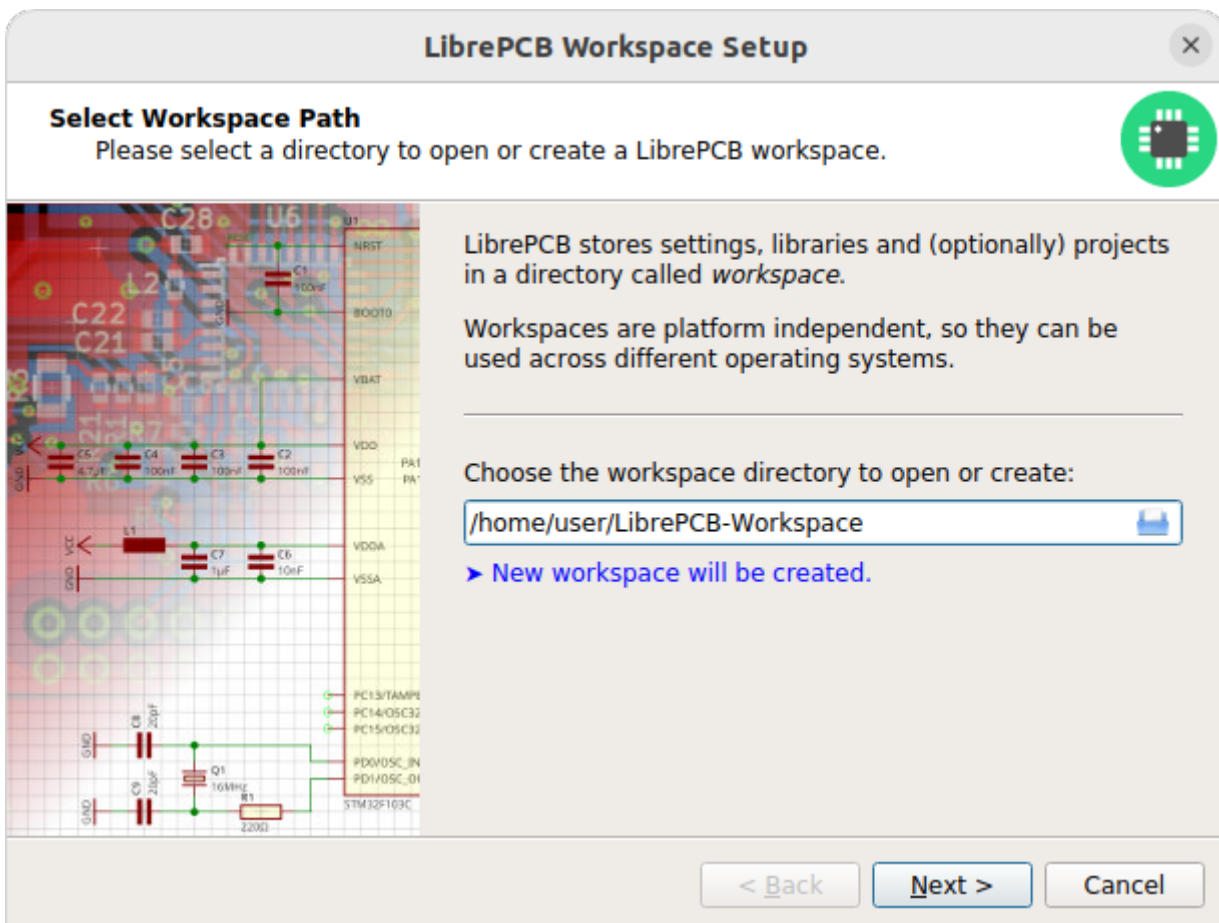

If the selected path does not contain a workspace yet, clicking on [Next] will show a page to choose the most important settings:

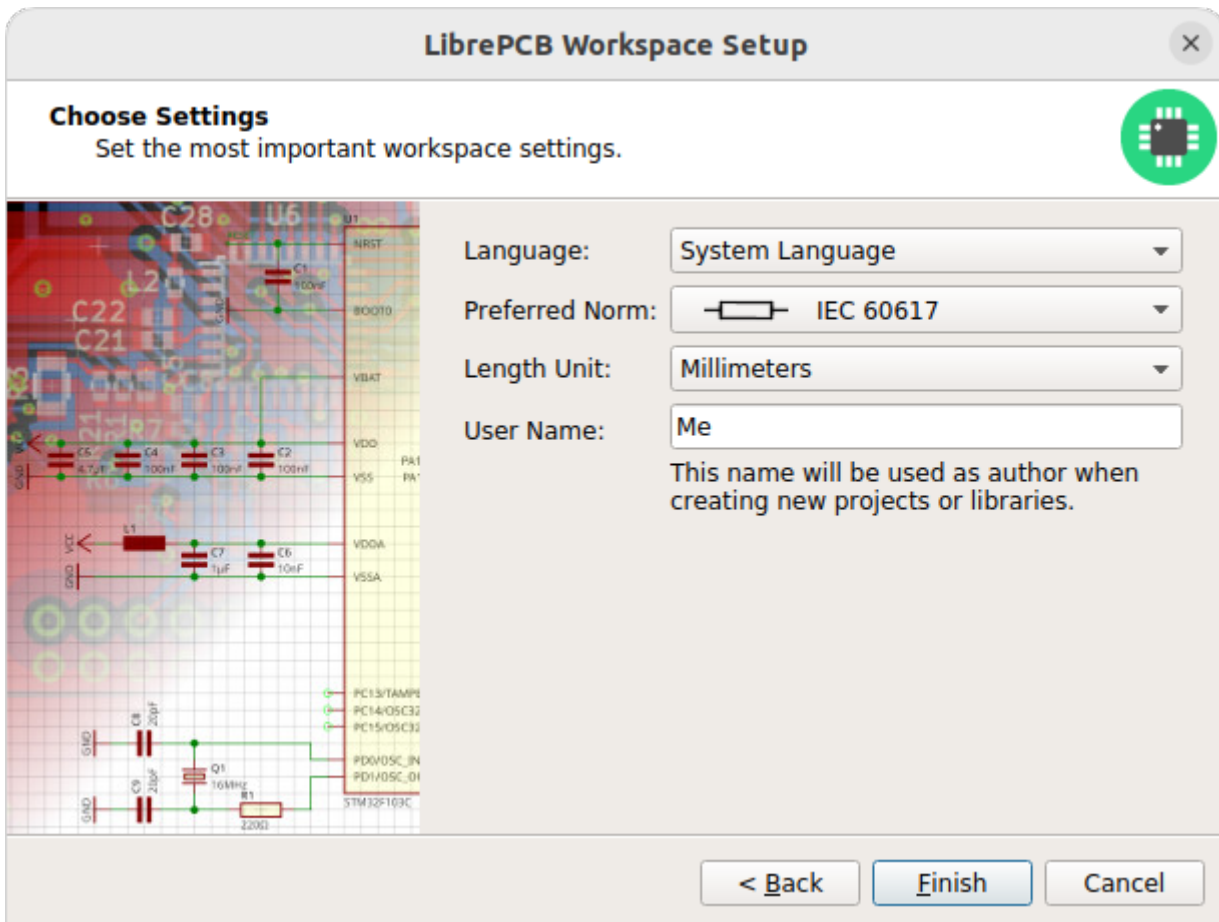

It is recommended to select at least your **preferred norm** and **length unit** since these usually depend on where you're living.



You can change these settings at any time later in the control panel under **Extras > Workspace Settings**.

After clicking [**Finish**], the control panel shows up and you're ready to start using LibrePCB!

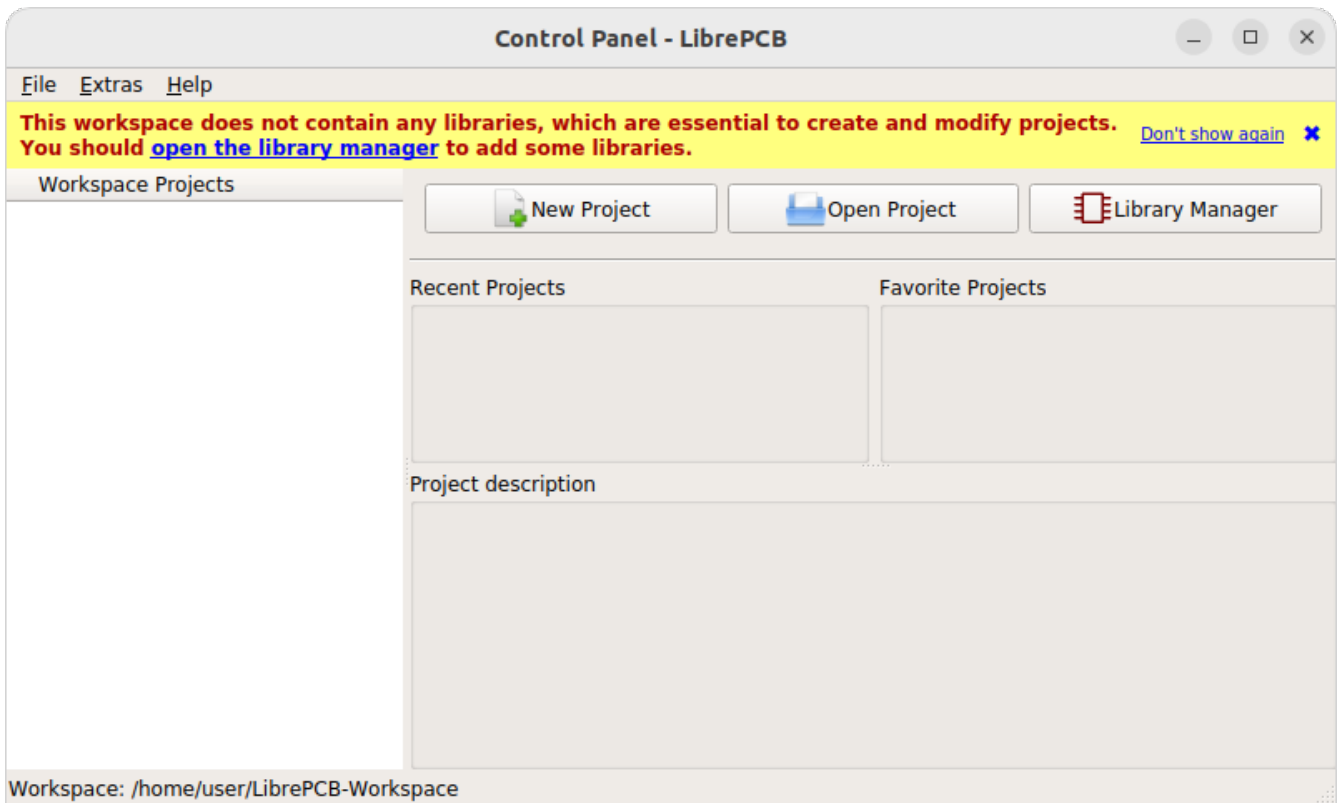

Install Remote Libraries

Before you can start creating new projects, you need to add some libraries to your workspace. Libraries contain various kinds of elements which can be added to schematics and boards (e.g. symbols, footprints and devices).

Click on [**Library Manager**] in the control panel:

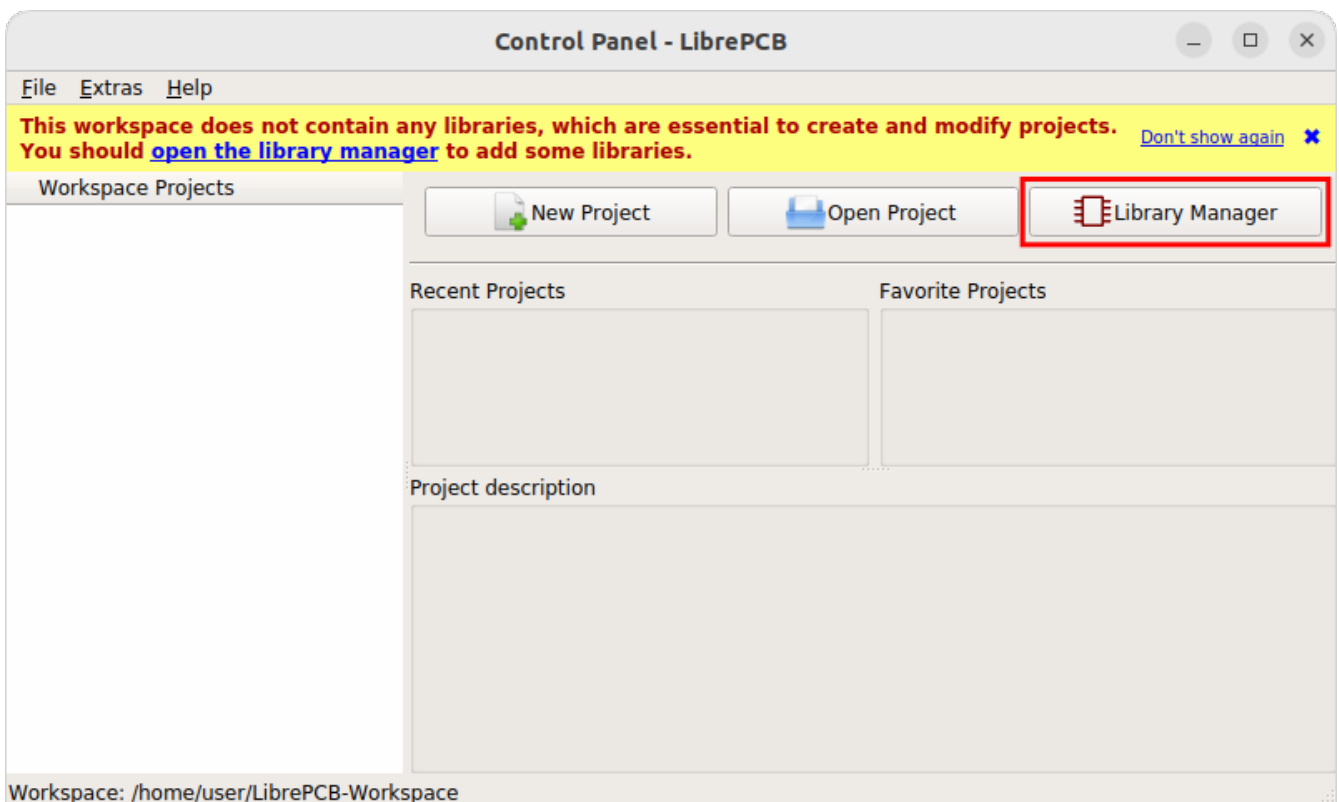

The library manager immediately fetches the list of available libraries from the Internet. Most of these libraries are hosted at github.com/LibrePCB-Libraries.

The most important library is *LibrePCB Base* because it contains commonly used library elements like resistors or diodes. It is highly recommended to install at least this library. However, you can even simply install all the available libraries at once:

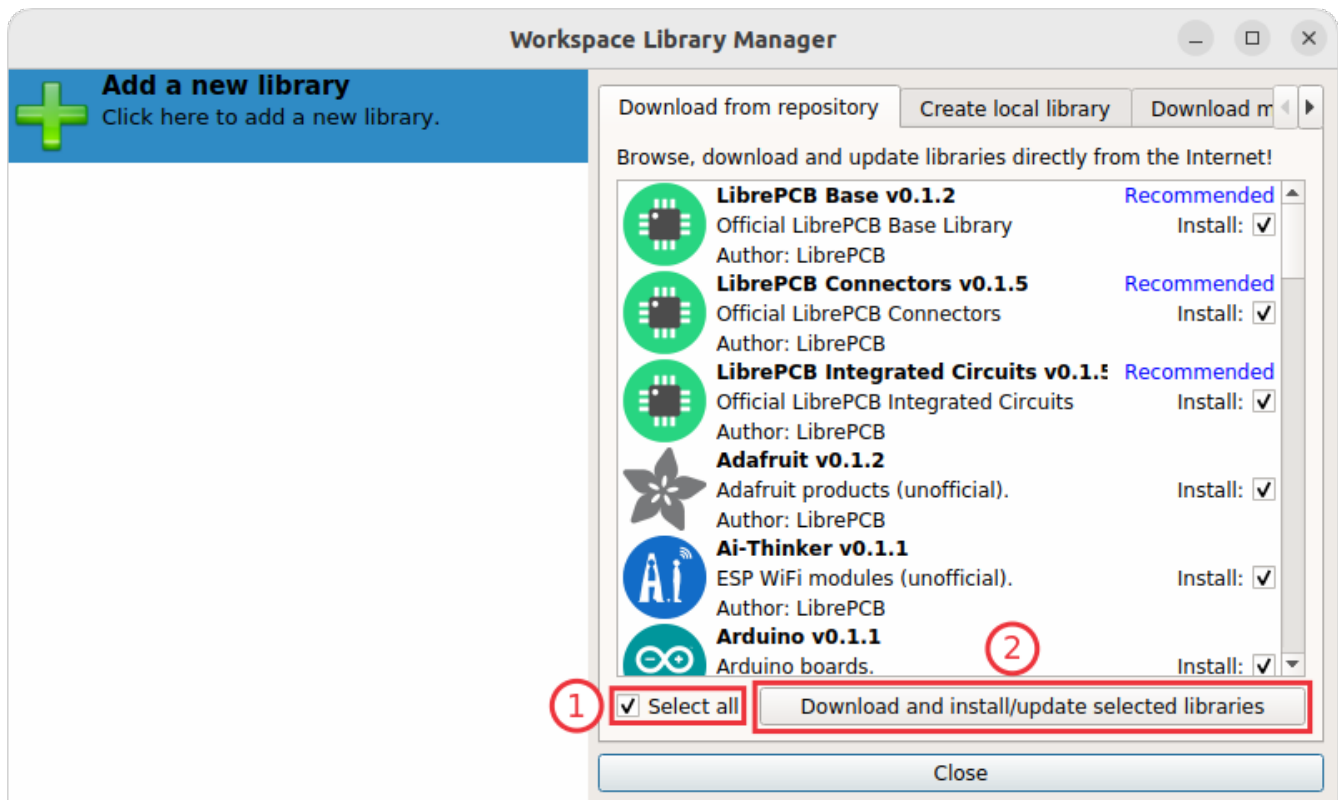

Later you can keep the installed libraries up to date exactly the same way. Just open the library manager from time to time to see which libraries can be updated to a new version.



Dependencies between different libraries are automatically taken into account when changing the selection. So for example if you select *LibrePCB Connectors*, the *LibrePCB Base Library* will automatically be selected too because the connectors library depends on it.



Downloaded (so-called *remote-*) libraries are always read-only because otherwise local modifications could cause conflicts when updating the library the next time. But this is no problem, just follow this tutorial to create your own local library later. In a local library you can use or even override library elements from remote libraries by specifying a higher version number.



If you are familiar with version control systems (e.g. *Git*) and want to use them to manage your libraries (instead of the library manager), just clone the libraries into the subdirectory `data/libraries/local/` in your workspace.

After the selected libraries have been downloaded, they will appear in the list of installed libraries on the left side of the library manager:

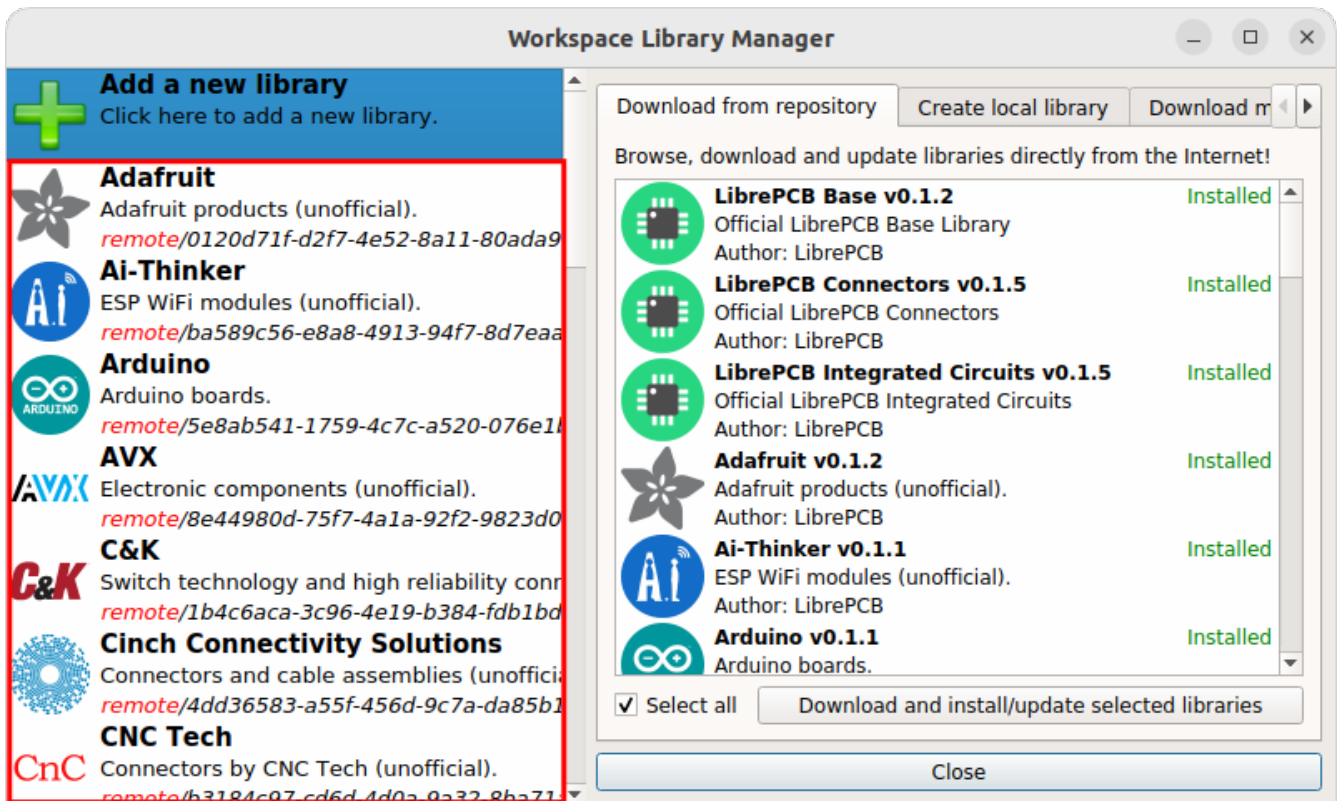

Note that after the libraries were installed, it takes a moment to create an index of all the contained elements. This process automatically runs in background and is indicated with a progress bar at the bottom right of all main windows. The installed libraries are ready to use once the progress bar disappears.

Create a Local Library

In addition to the (read-only) remote libraries, you should create a personal, so-called *local* library. This is the place where you'll add your own symbols, footprints etc. later.

To do so, go to the *Create local library* tab, optionally enter some metadata (default values are good enough) and click on [**Create Library**]:

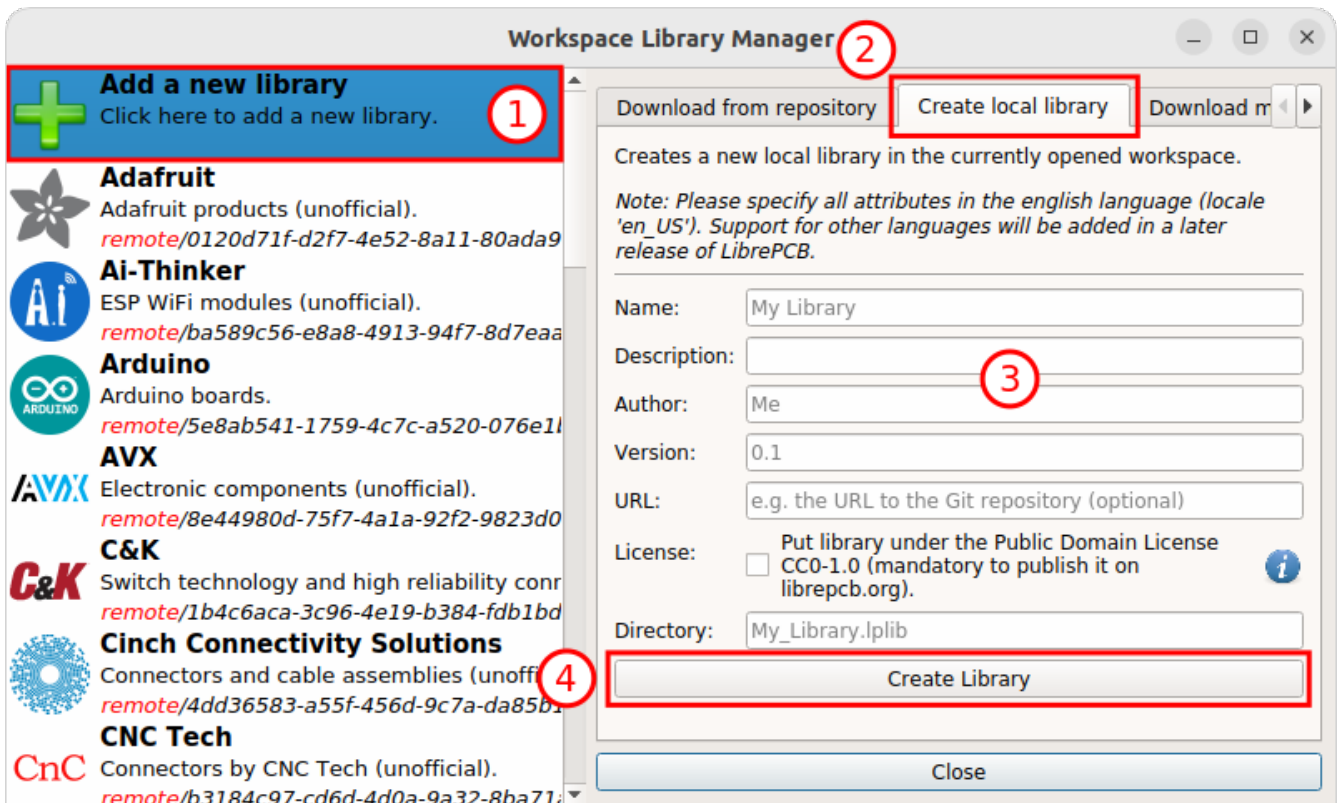

If you're curious how the library looks like, select your library on the left and then click on [**Open Library Editor**] (or just double-click on your library):

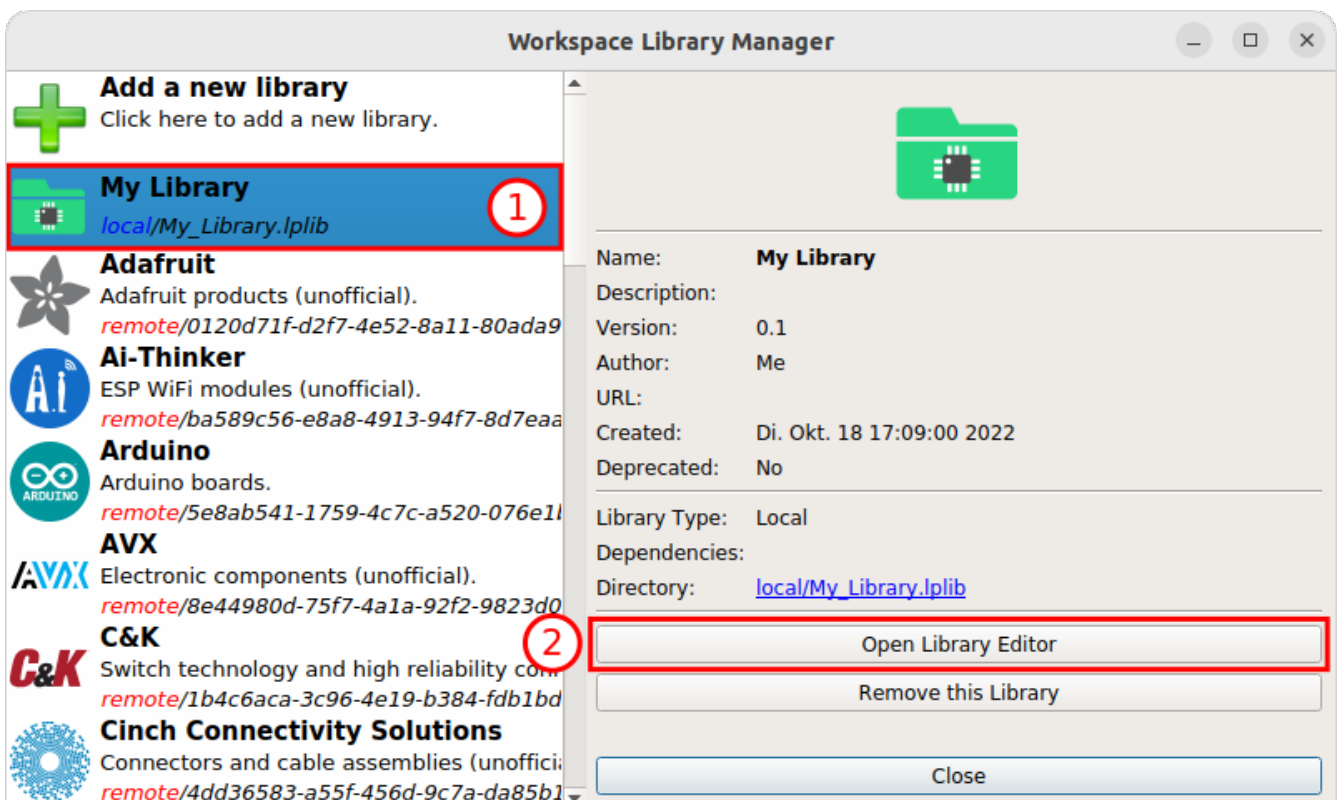

You'll see an empty library editor since the library doesn't contain any elements yet.

Your workspace setup is now complete and ready to start creating your first PCB project! You can close both the library editor and the library manager for now. We'll come back to the library editor later when we need to [create our own library elements](#).

Create a PCB Project

In LibrePCB, schematics and boards are always part of a project, so before creating schematics and boards you first need to create a project for every PCB. Click on **[New Project]** in the control panel:

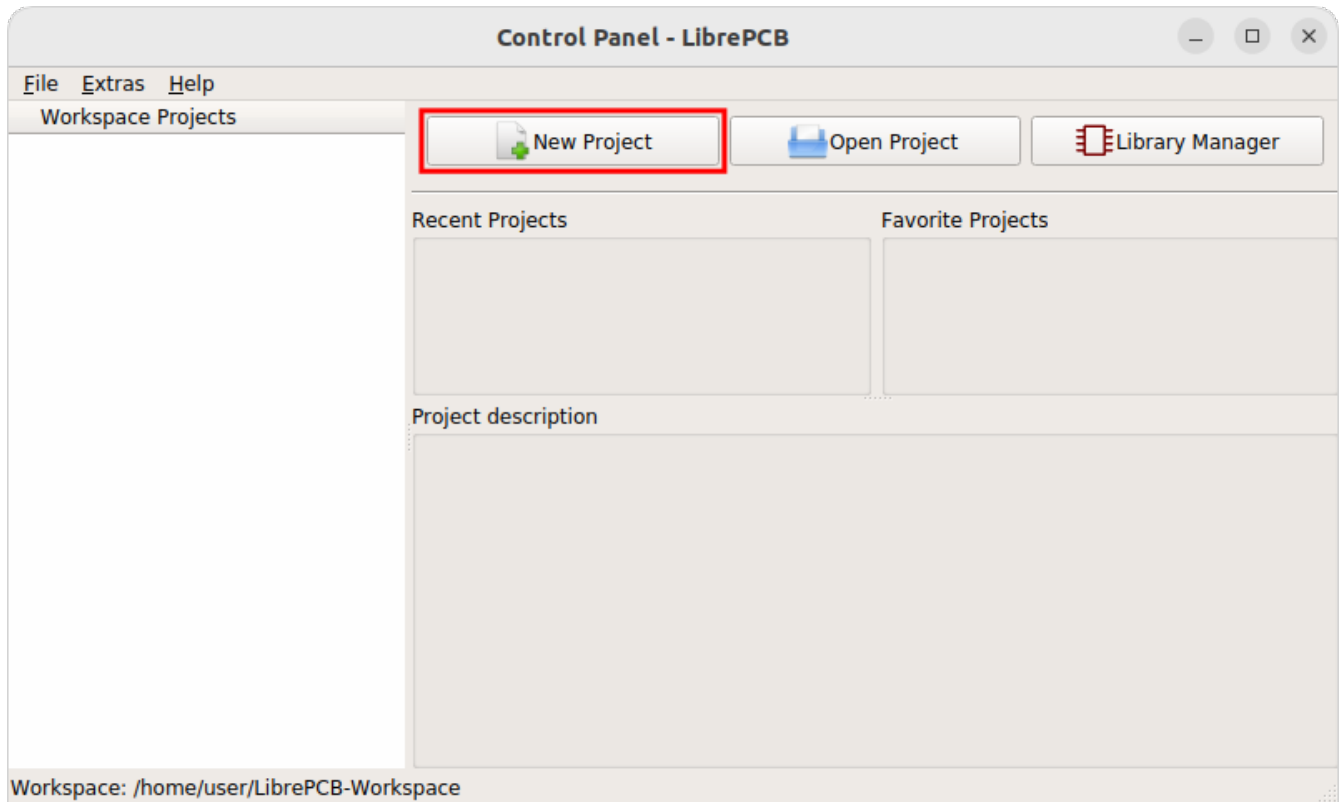

Then specify some project metadata:

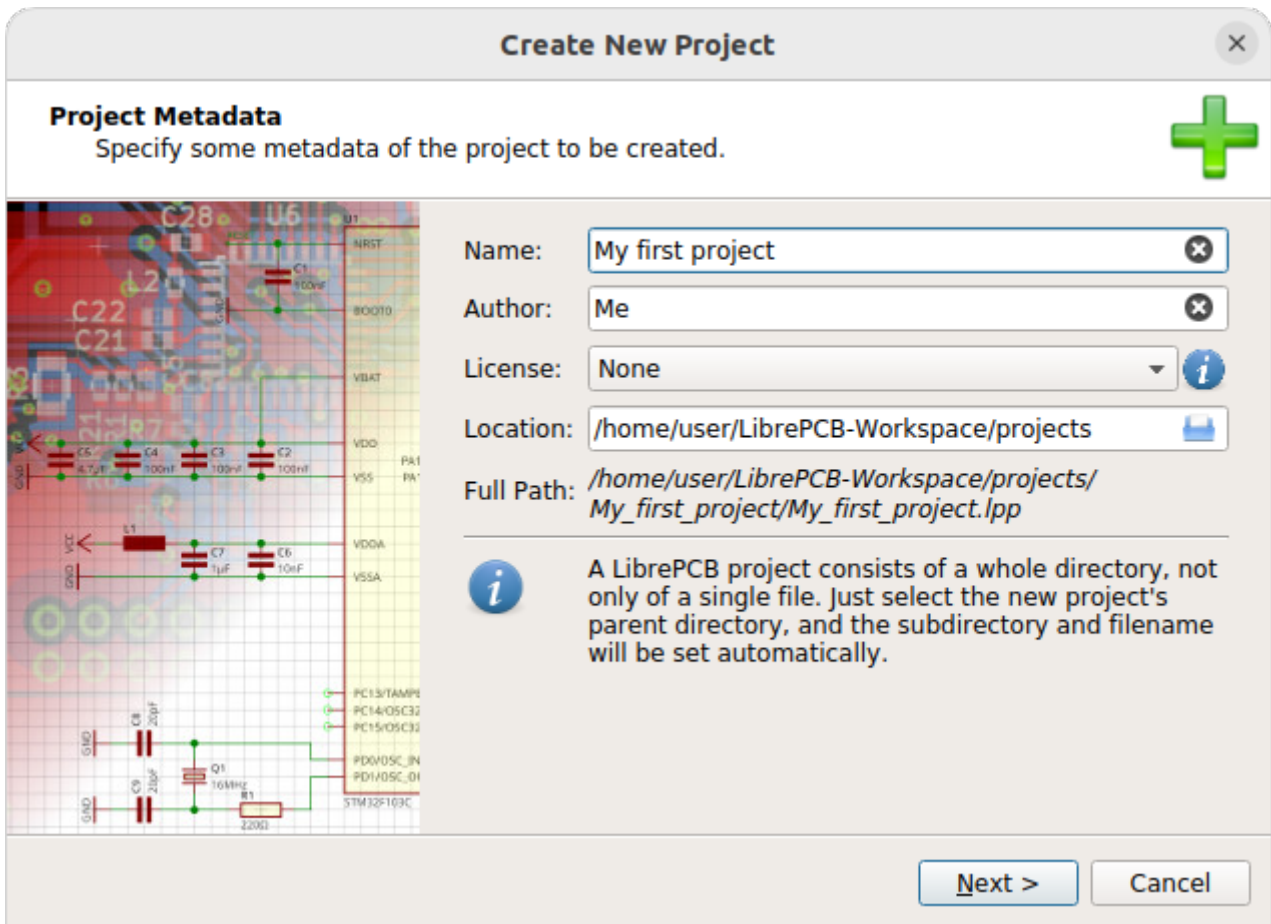

It's recommended to store projects within the workspace subdirectory named **projects** (the default location suggested by the wizard) because these projects are then shown in the control panel file explorer, making them easy to locate and use. But of course projects can be created at any other location as well.



A LibrePCB project consists of a whole directory on the file system. While it is possible to manually add/modify files in that directory, generally you should avoid adding large files (e.g. datasheets) since this *could* slow down some operations. It's better to store unrelated files outside of the project directory.

Now you can choose whether the project should be initialized with a first schematic page and board, and how they are named. If you are unsure, just accept the default values:

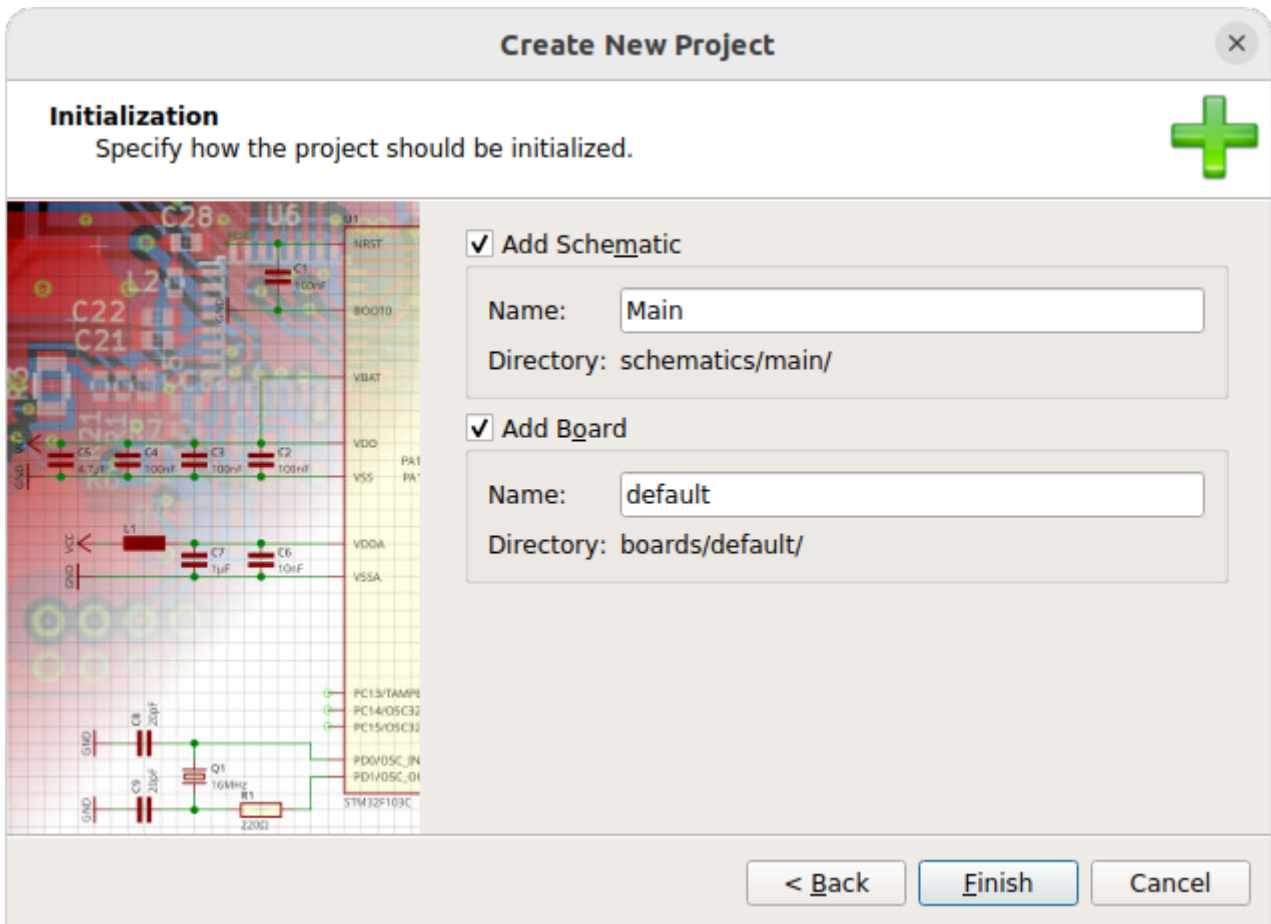

After clicking on [**Finish**], the schematic- and board editors show up:

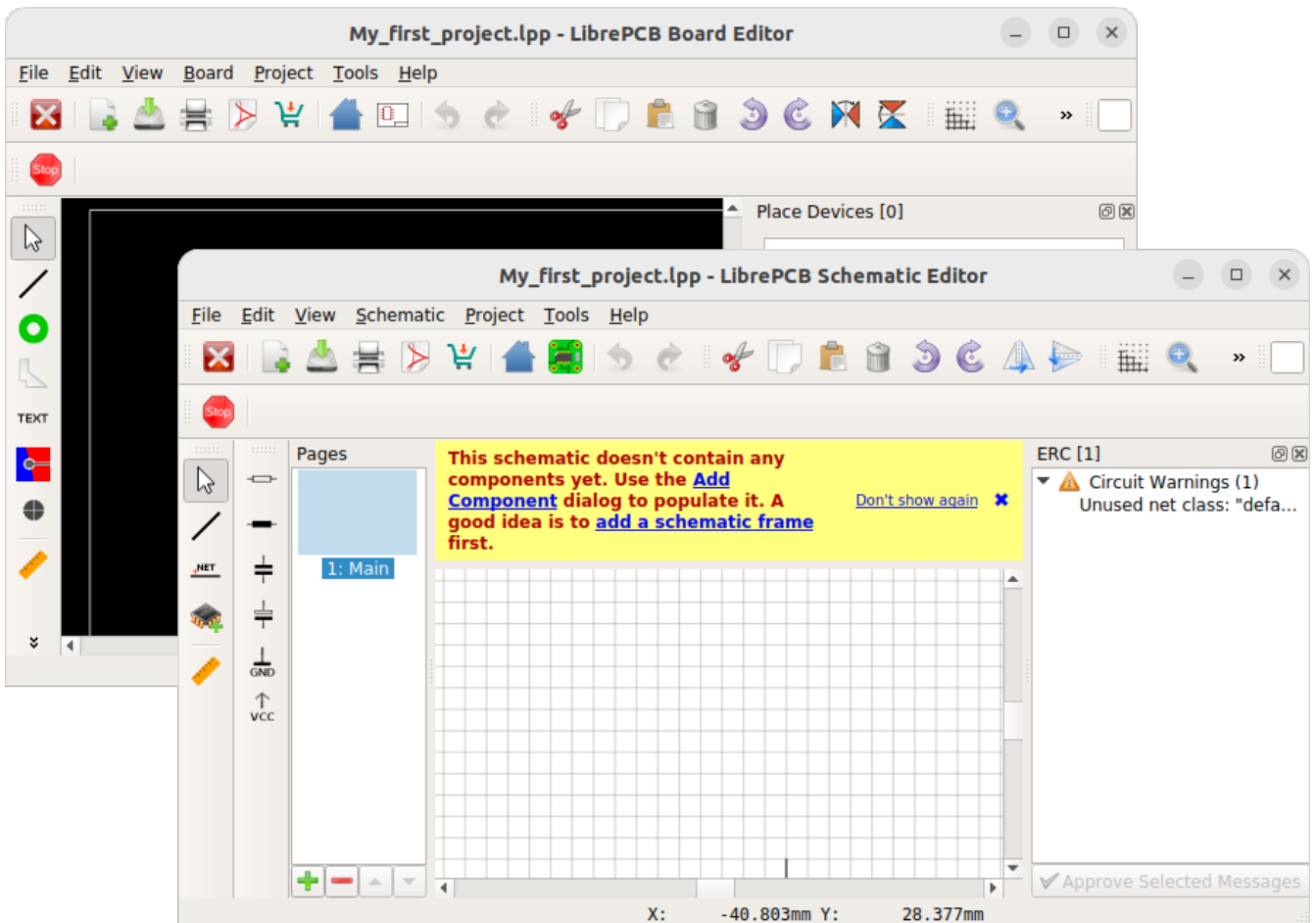

Create Schematics

Before starting with the board layout, a schematic will be needed. So let's see how to draw a schematic.

Add Frame

First, you may want to add a frame to the schematic. Click on [**Add Component**] in the toolbar and select a schematic frame:

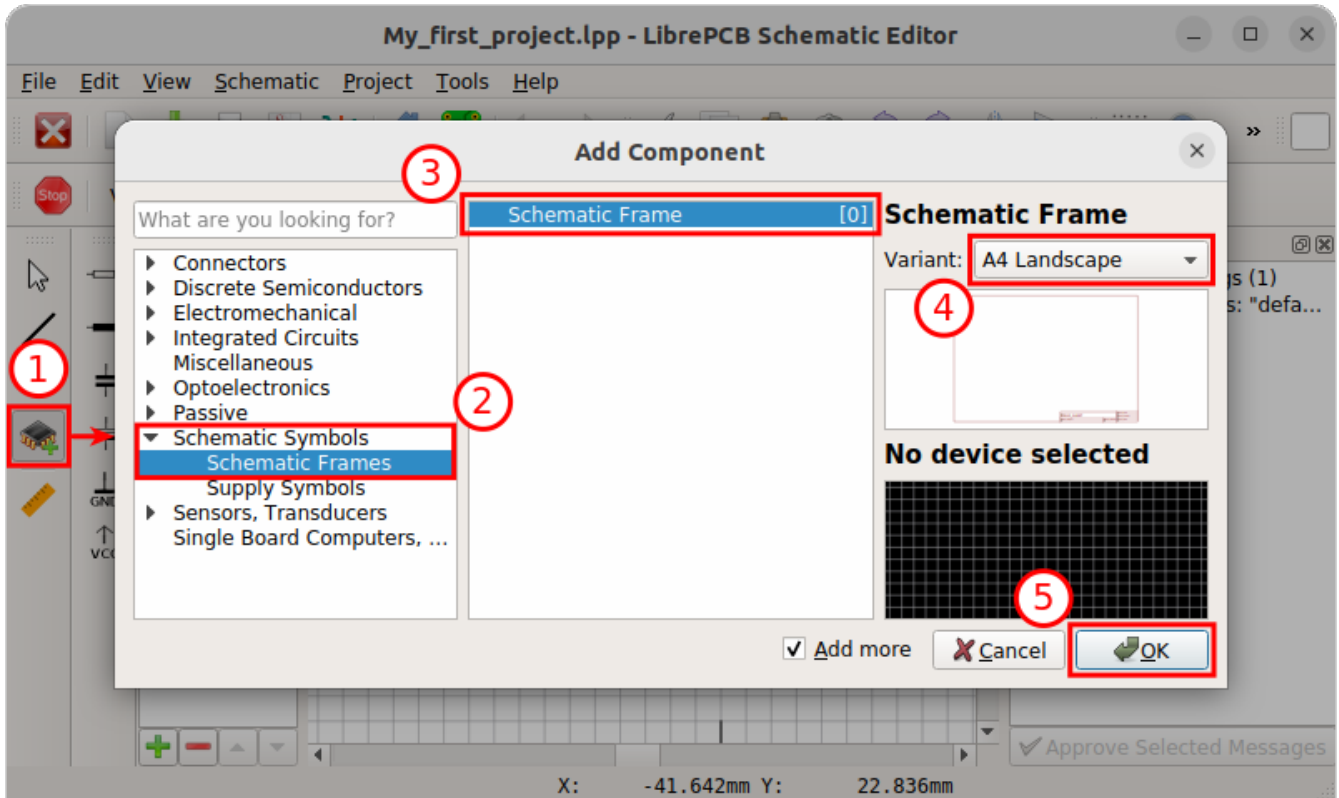

After clicking on [**OK**], the selected component is attached to the cursor. Click on the origin of your schematics to place the frame at coordinate (0, 0).

Press **Esc** to finish the placement. The *Add Component* dialog pops up again to choose the next component. Press **Esc** again to leave the tool.

Add Components/Devices

Now add all the resistors, capacitors, ICs etc. the same way to your schematic. However, for real parts (in contrast to the schematic frame) the dialog lets you select a concrete device. Here an explanation about the displayed information:

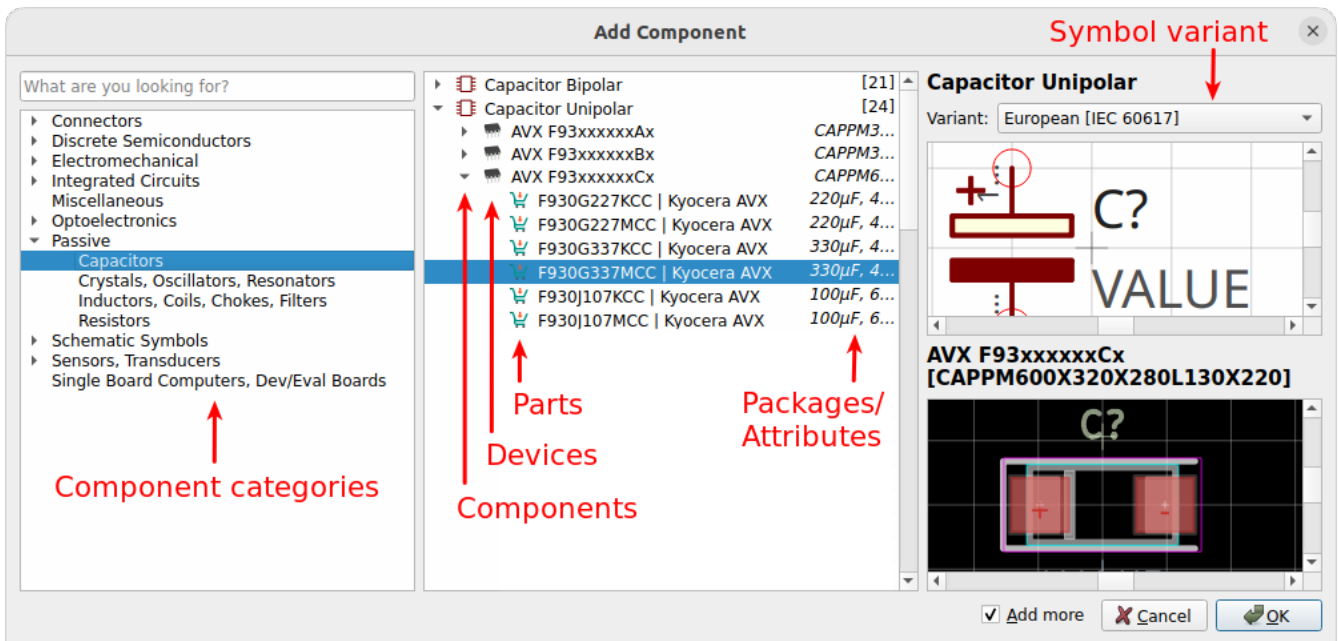

You can choose between adding a **component** a **device** or a **part**:

- **Component:** Defines the schematic symbol and netlist signals. It's all you need in a schematic, but it does not represent a concrete part and does not specify the package to be placed on the board.
- **Device:** Defines the package to be used in the board. Basically it's the combination of a component and a package with a particular pinout.
- **Part:** Represents a real, orderable part. In addition to defining the package, it also defines the exact MPN^[1] which will appear in the BOM^[2].

To add something to a board, you need to choose a **device** or a **part**. However, it's your choice whether to select it *now* or *later* when starting with the board layout. This allows to draw the complete schematics even if various packages and devices do not exist yet in your libraries.



While placing components, press **R** to rotate or **M** to mirror. With **Tab** the focus is moved into the toolbar to allow specifying a value.

Supply symbols like VCC or GND are added exactly the same way since these are ordinary library elements as well. However, they are also provided in a dedicated toolbar for a quick access to the most commonly used elements.



The *Add Component* dialog lists all the components, devices and parts available in the libraries you have installed in your workspace. **If you are missing something, you either need to install more libraries or create your own library elements.**

To create your own library elements, follow the linked tutorial. You can keep the project open while working in the library editor. Afterwards, **wait for the background library scan to complete** (indicated as a progress bar at the bottom right of the window). Then the new library elements will appear in the *Add Component* dialog and are ready to be used.

Draw Wires

Once your schematic contains some components, the pins can be connected with the [**Draw Wire**] tool. Just click on a pin to start a new wire:

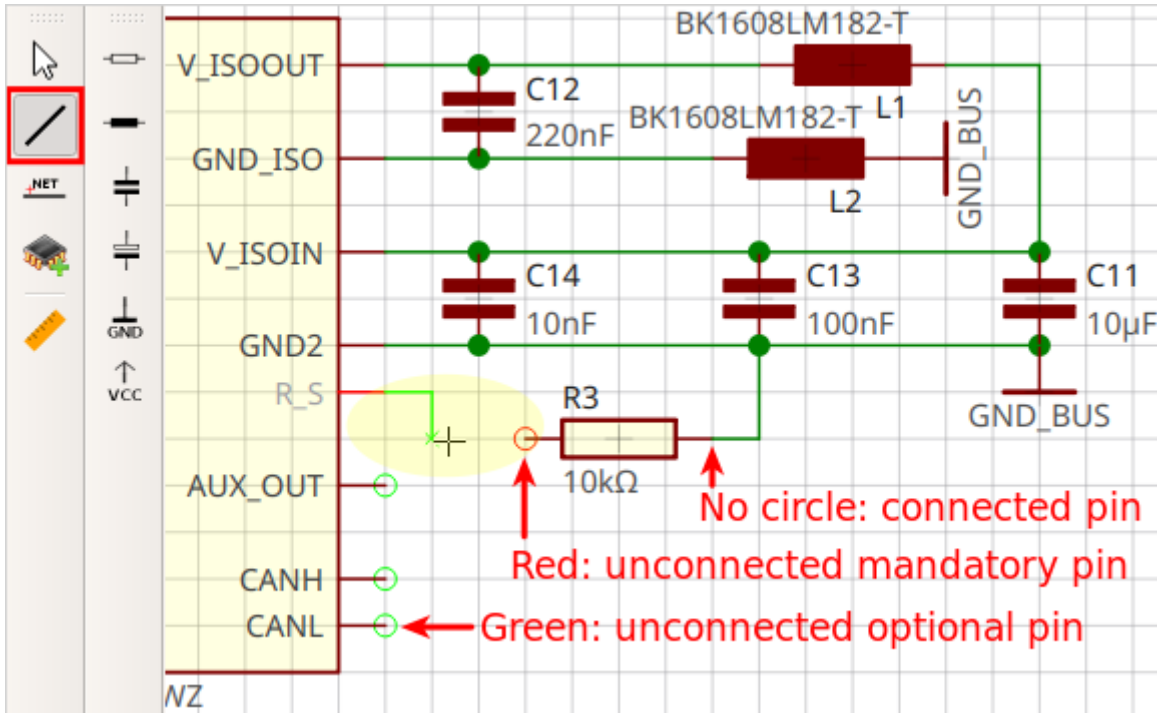

Pay attention to the circles around the pins. If a wire appears to be starting at a pin, but the circle is visible, it is **not** connected.

The color of the pin circles even provide some more context:



- **Red:** Mandatory pin, i.e. needs to be connected to a wire (if not, an ERC^[3] warning is raised).
- **Green:** Optional pin, i.e. may or may not be connected, depending on the use-case. No ERC error will be raised if left unconnected.

Add Net Labels

To keep schematics clean and readable, net labels may be added. They allow to explicitly specify net names, and to create hidden connections between wires of the same net name.

1. Start the [**Add Net Label**] tool.
2. click on the wire where to attach the label.
3. Click to specify the label position.



While placing labels, press **R** to rotate.

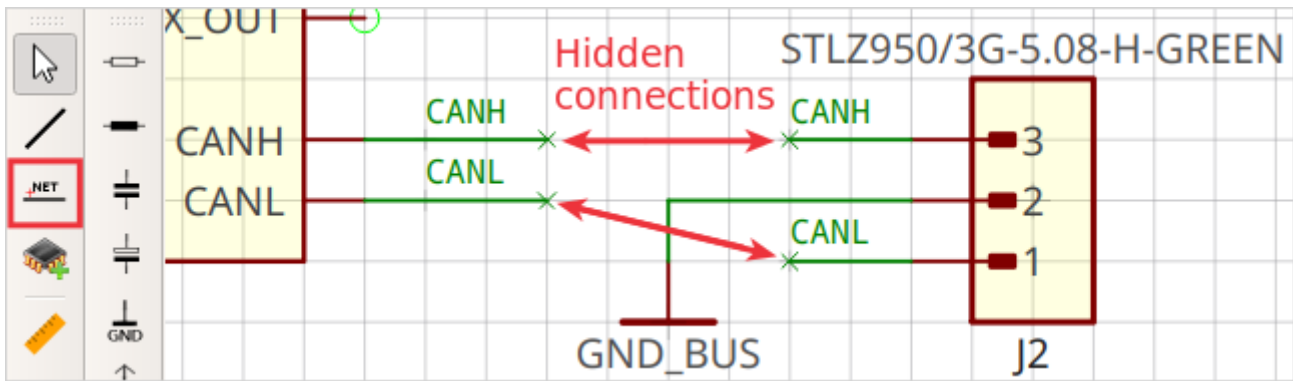

All wires in the whole project which have the same name assigned will automatically be connected, even across schematic pages.

Add More Sheets

For larger projects, you may want to split the schematics into multiple sheets for better readability. Just add more sheets with **Schematic > New Sheet**, then add a frame and devices the same way. Use supply symbols and net labels to connect nets across pages.

Electrical Rule Check

At latest when you're finished with the schematics, you should check if there are no critical ERC messages. The ERC does not need to be triggered since it is automatically updated.

Open the ERC dock with **View > Go to Dock > Electrical Rule Check (ERC)**:

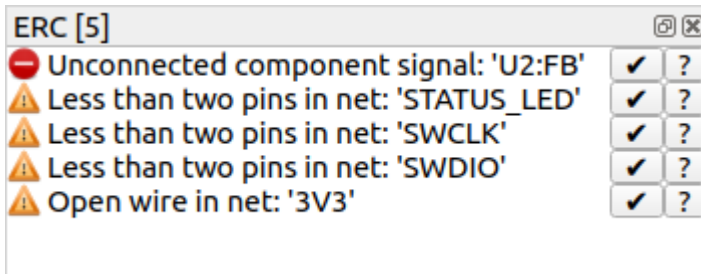

Click on [?] to get some more information about a message. If you're sure a message is not relevant, you could approve it with [] but usually warnings/errors should be fixed instead of approved.

Create Board

Once the schematic is (more or less) complete, you can start designing the PCB in the board editor. If the board editor window is not opened already, click on the [**Board Editor**] toolbutton to open it.

Set Grid Properties

All board editor tools (e.g. the *Draw Trace* tool) work on a particular grid interval, i.e. the cursor snaps on a multiple of that value. The value might depend on the task you're working on so probably you'll need to change it several times while working on the board.

You can change it at any time with the [**Grid Properties**] toolbutton (or with **F4**):

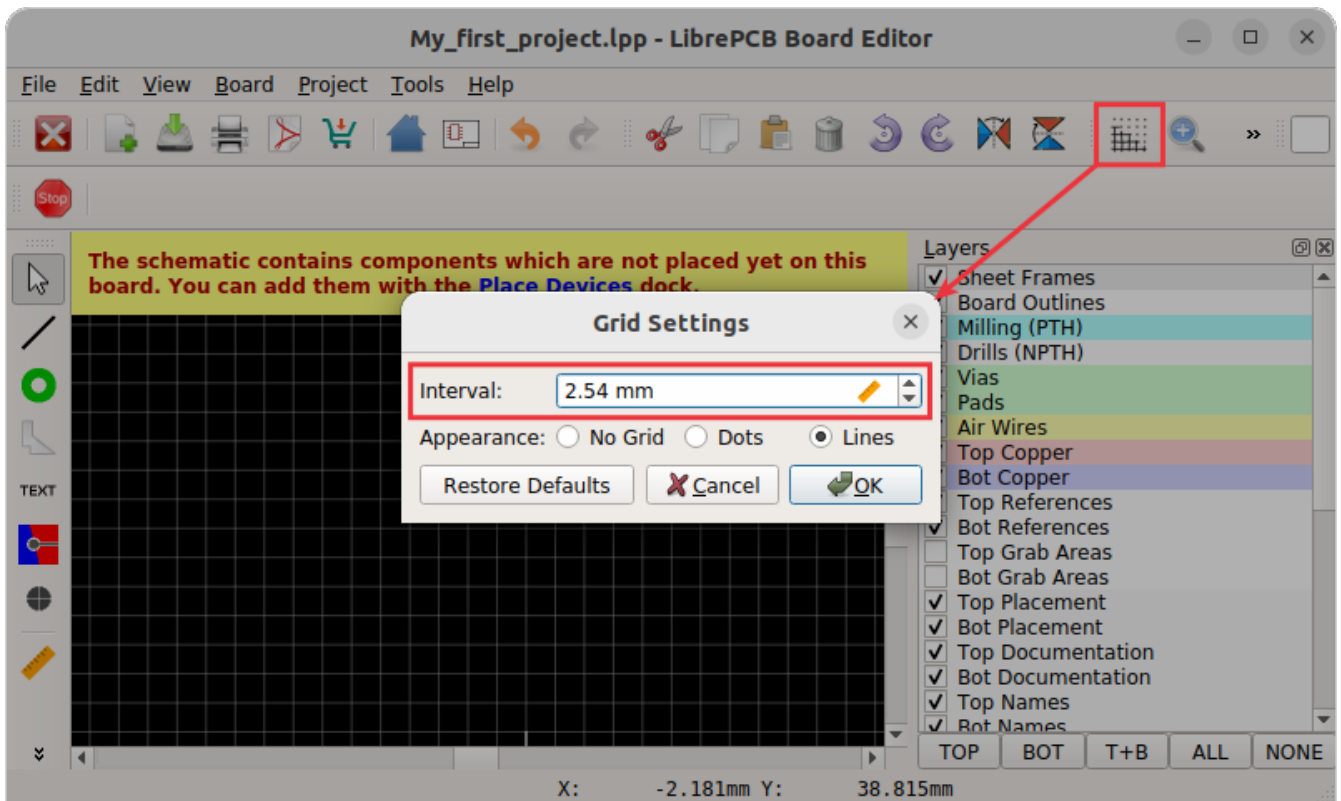

Draw Outlines

The most important thing of the board is its outline. Generally there must be a **single, closed polygon on the *Board Outlines* layer**. It is recommended to set its **line width to 0.0mm** since — in contrast to many other polygons — this polygon does not represent any actual material but only the outer dimension of the PCB.

If your PCB needs non-plated cut-outs (e.g. slots, windows, ...), draw these polygons on the *Board Cutouts* layer with a width of 0.0mm.



A simple board outline polygon is automatically added by LibrePCB when creating a new project or board! So usually the only thing you need to do is to **resize it to the desired size**. The instructions here are intended only to explain more complicated scenarios and in case you want to re-draw the outline from scratch.



All polygons on the *Board Outlines* and *Board Cutouts* layers shall represent the actual board outlines (i.e. the edges), **NOT** the paths for the milling cutter! The PCB manufacturer will automatically offset the outline polygons to calculate the actual paths for the cutter.

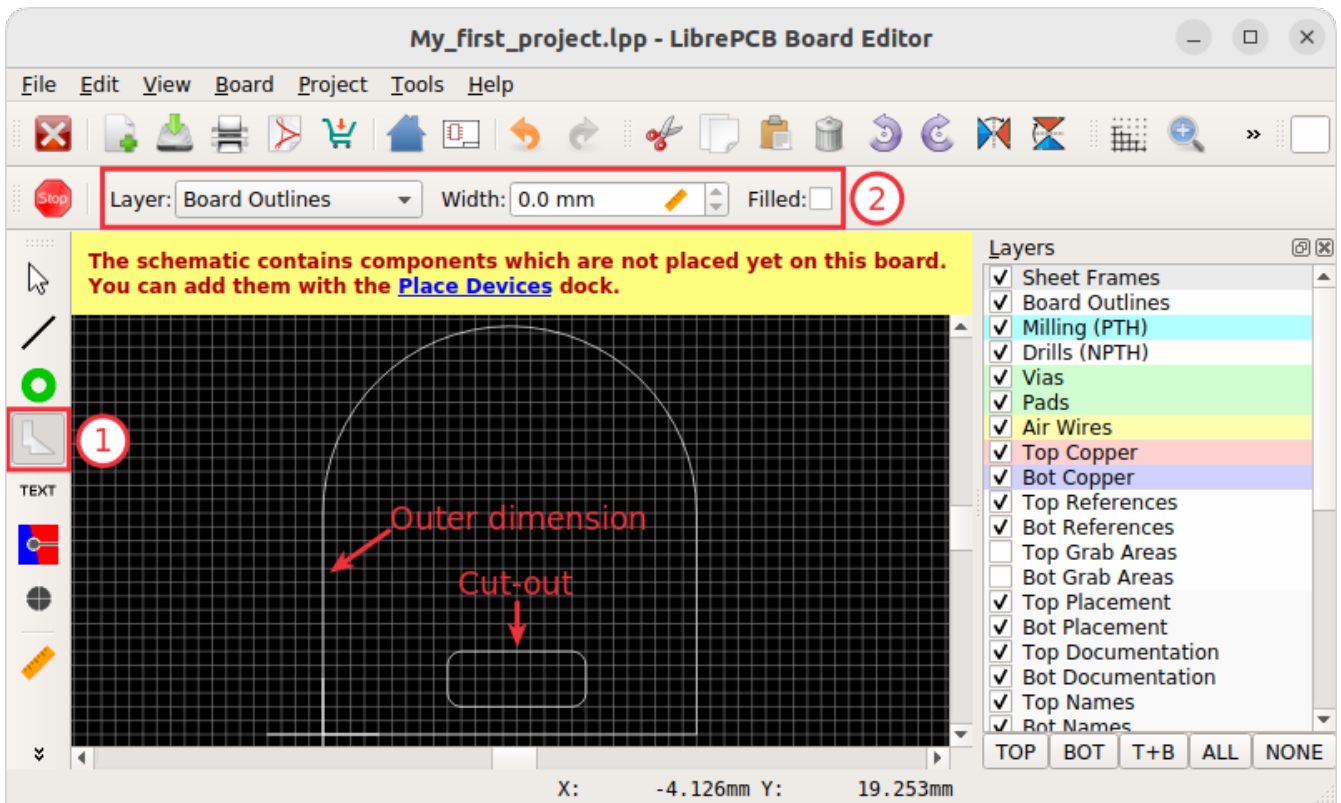

Keep in mind that inner edges can only be produced with a specific minimum radius (corresponding to the milling cutter diameter of the PCB manufacturer). Although PCB manufacturers may produce your PCB anyway even if it contains inner edges with no or too small radius, it's highly recommended to draw all inner edges with a proper radius. Often a radius of 1.2mm or more works fine, while a smaller radius might lead to additional cost.

To draw polygons with arcs, open **[Properties]** from the polygon's context menu (right-click) and specify the vertex coordinates and angles manually.

A correct board outline is really crucial to avoid problems during the PCB manufacturing process! Make sure to fulfil these rules:

- There's exactly one polygon on the *Board Outlines* layer.
- Cut-out polygons (if there are any) are on the *Board Cutouts* layer and located fully inside the outer board outline.
- There are no tangent or intersecting polygons on these two layers.
- The line width of those polygons is 0.0mm (optional, but recommended).
- Polygons are closed (start and end coordinates are exactly identical) and consisting of a single polygon object (**NOT** multiple joined lines!).
- There are no other objects on these two layers.

An easy way to check if the board outline is valid is to review the PCB in the 3D viewer. For that, open **View > Toggle 2D/3D Mode** or press **Ctrl + 3**.

Place Devices

For every component in the schematic, you need to place a device in the board (except schematic-only components, like the schematic frame).

1. Open the *Place Devices* dock (**View** > **Go to Dock** > **Place Devices**).
2. Select a component to place.
3. Select the desired device for that component (not needed if the device is already specified in the schematics).
4. Choose the exact footprint to place, if there are multiple. Most packages have only one footprint — if not, the default footprint is pre-selected.
5. Click **[Add]** and place the device with the cursor on the board. Press **R** to rotate or **F** to flip to the other board side while moving.

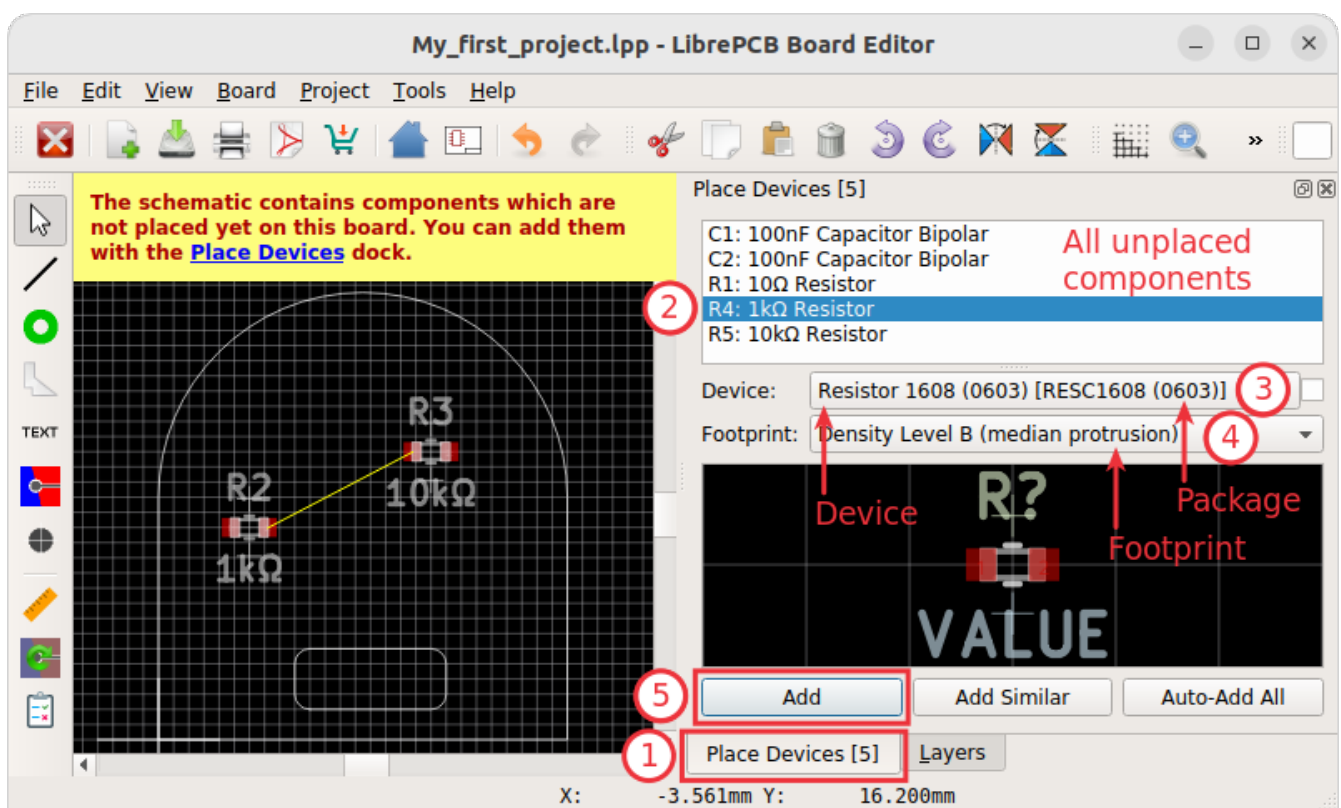

Repeat these steps until there are no more unplaced components.



If you want to use the same device and footprint for all instances of a particular component, use the **[Add Similar]** button to add all at once.



If you can't find the desired device for a component (or the device dropdown is completely empty), you need to add the device to your local library first. Continue with the [library element creation tutorial](#) and come back to the board editor once the device is created.

By the way, it's even possible to replace devices after adding them to the board. For example you can replace a 0603 resistor by a 0805 resistor using the **[Change Device]** context menu item (right-click):

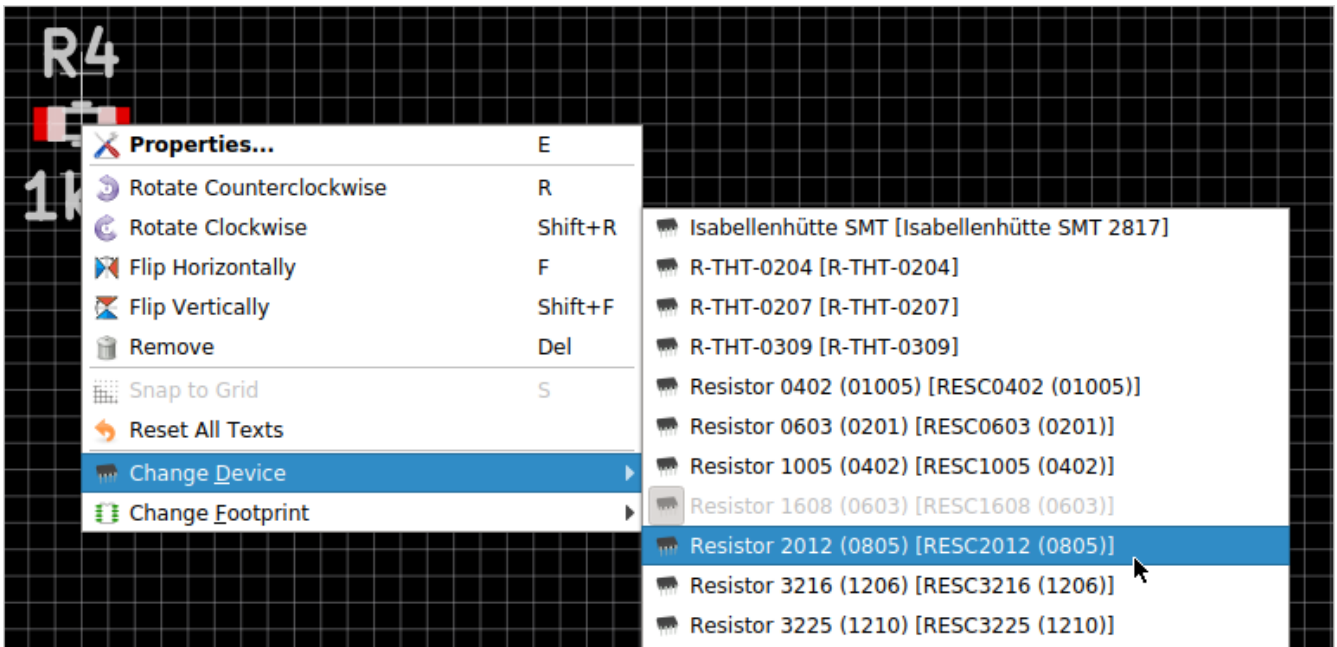

Exactly the same way you can switch to a different footprint, just use the [**Change Footprint**] context menu item instead.

Draw Traces

As soon as you add devices to the board, airwires will appear to show the missing traces. Start the [**Draw Trace**] tool and specify the trace settings in the toolbar. Then click on a pad to start a new trace:

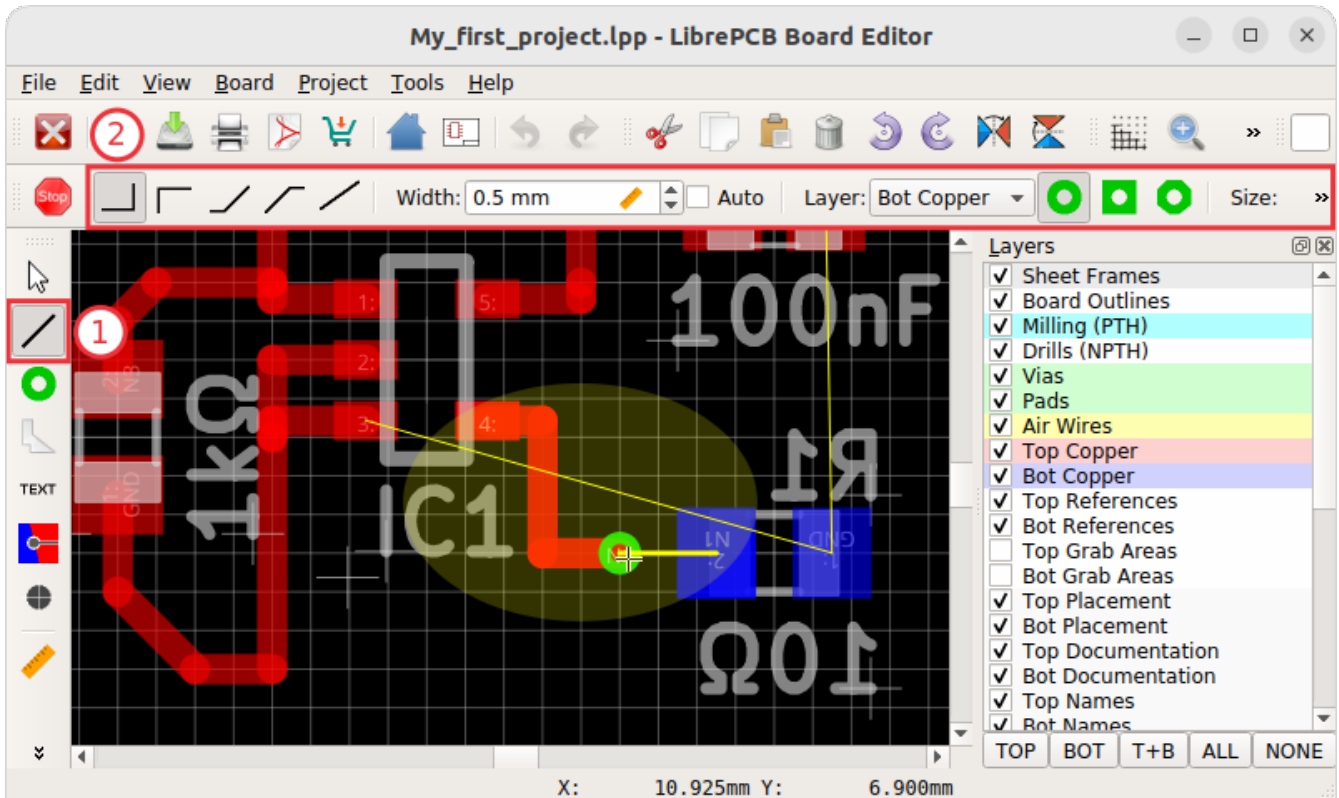

The cursor automatically snaps on objects of the same net. If this is not desired, hold **Shift** while drawing.

With the right mouse button you can cycle through the different routing modes.



To switch to a different copper layer while drawing a trace, press **Page Down** (next lower layer) or **Page Up** (next higher layer). This will automatically insert a via if needed.

There are also shortcuts to change trace & via properties, see **Help > Keyboard Shortcuts Reference** for details.

Add Planes (Copper Pours)

If you need planes (also known as *copper pours*, i.e. filled copper areas to create electrical connections), proceed as follows:

1. Start the [**Draw Plane**] tool.
2. Specify the electrical net and copper layer in the toolbar.
3. Add vertices with mouse clicks. To fill the whole board, an approximate outline is good enough since it will be clipped automatically.

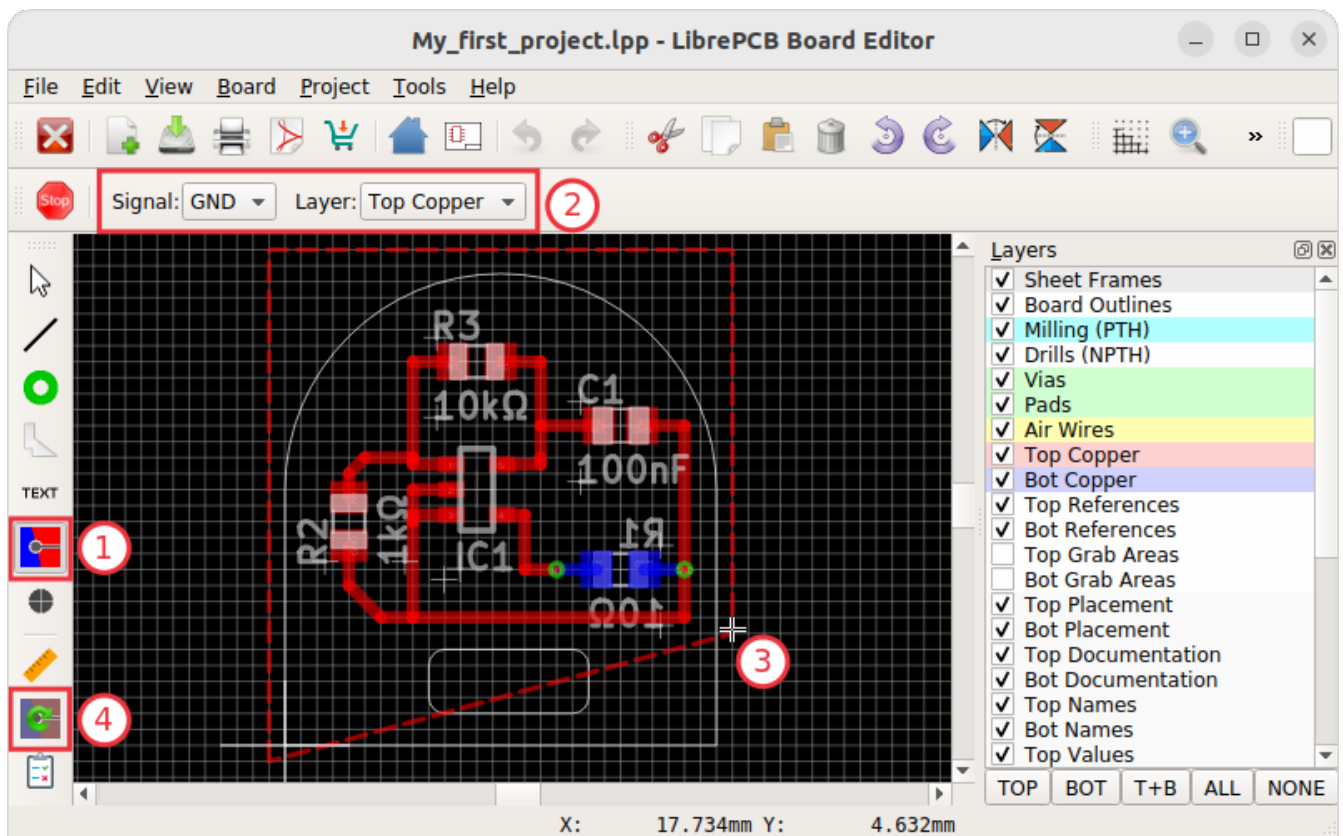

Once the plane area is calculated, it appears with a filled area. As you can see, the area is automatically clipped to the board outline:

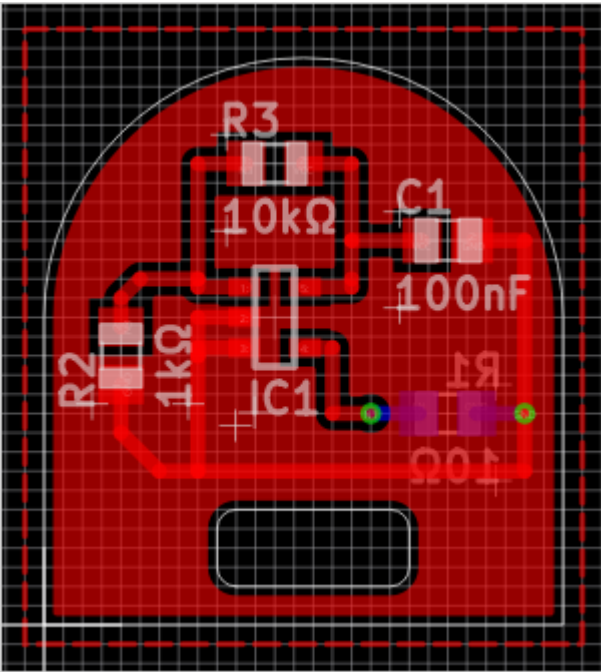

In case your plane does not get filled, make sure:

- The board outline polygon exists and fulfils all the [rules listed above](#).
- The plane is located *within* the board outlines.
- There is at least one copper element of the same net located within the plane area — e.g. a via, pad or trace. **Plane areas which are not connected to any copper element are automatically discarded** to avoid electrically "floating" copper areas on the board. If you prefer to add these copper areas anyway, open **[Properties]** from the plane context menu (right-click) and check the *Keep Islands* option.



To avoid plane areas cluttering up the view too much, they can be hidden with **View > Hide All Planes**. They will still be there, they are just hidden on the screen.

To interconnect planes on different copper layers, just place vias with the **[Add Via]** tool within the plane areas. Make sure the vias have the same net as the plane. Vias will also prevent plane fragments from disappearing if there's no other copper element within the plane and the *Keep Islands* option is disabled.

Add Non-Plated Holes

Non-plated holes can be added to the board with the **[Add Hole]** tool. Just specify the diameter and click on the desired position. Afterwards, use the **[Properties]** context menu item to specify the exact position if needed (e.g. if not located on the grid interval).

Design Rule Check

Once your design is complete, you should run the design rule check (DRC) to ensure there are no critical mistakes.

But first you should check or adjust the design rules which are used to calculate via/pad restrings

and cream/stop mask clearances. For that, open **Board** > **Board Setup** or press **F7** and navigate to the **Design Rules** tab:

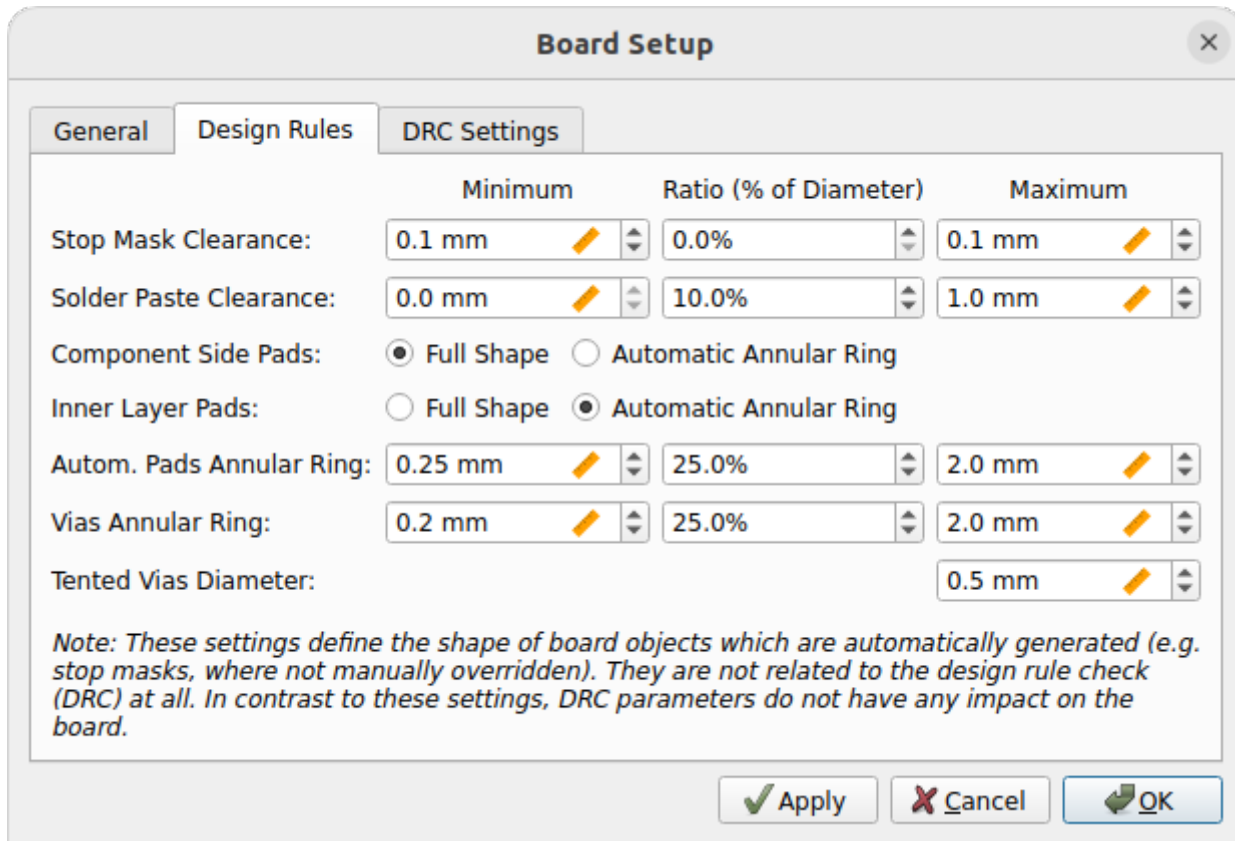

Actually it's better to set the design rules *before* drawing traces and adding planes since they affect the clearances. It is only moved to the end of the boards tutorial to keep the focus on the design workflow.

Fortunately, usually the default values are fine. So if you're unsure about these values, just keep the defaults.

Afterwards, navigate to the next tab called **DRC Settings** and configure the settings according the capabilities of your desired PCB manufacturer:

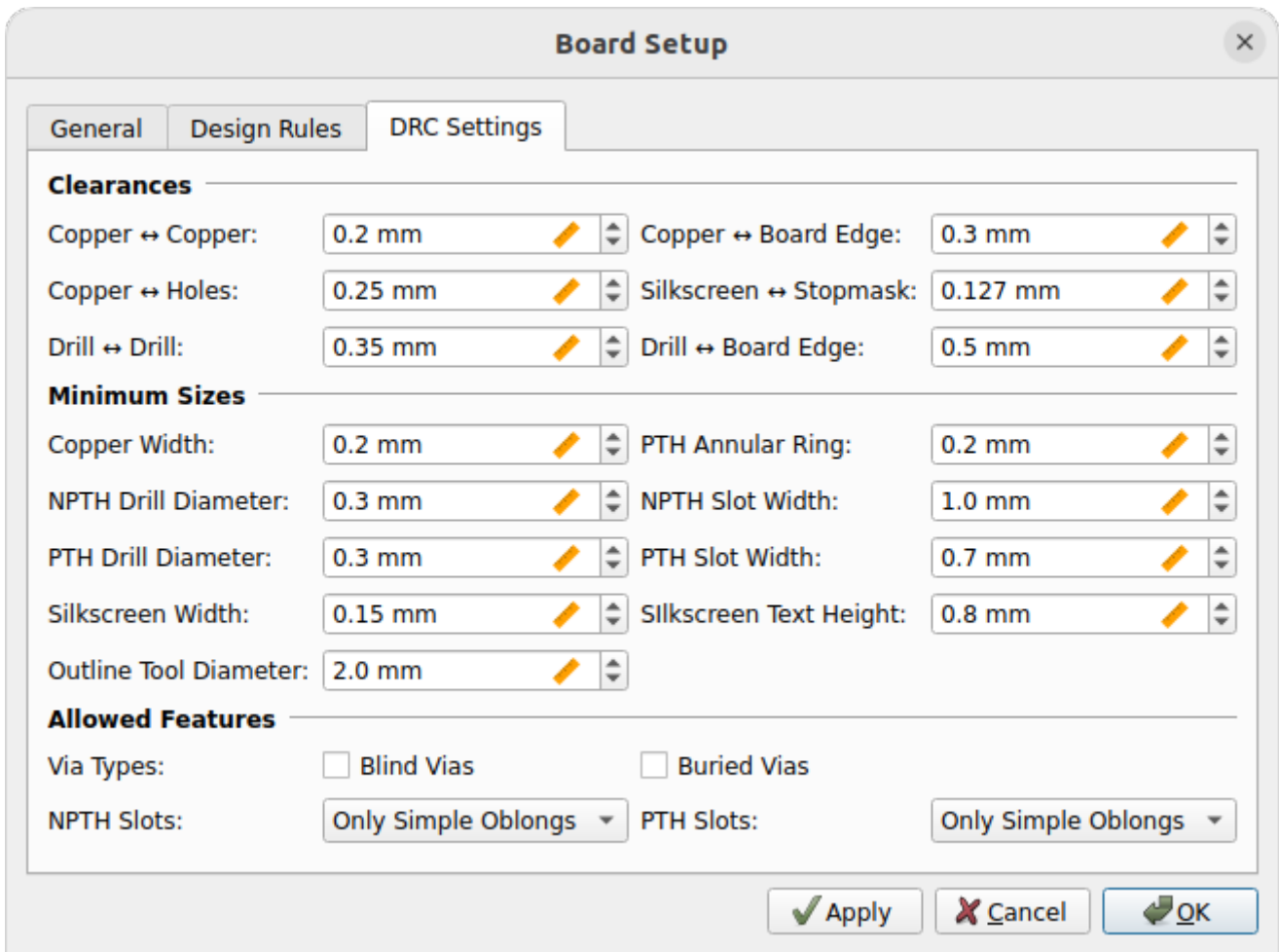

If you're unsure, just skip this for now (the default values are usually fine).

Once all settings are configured, open **Board** > **Design Rule Check** or press **F8** to run the DRC. This can take some time. The DRC dock widget should automatically appear to display the result:

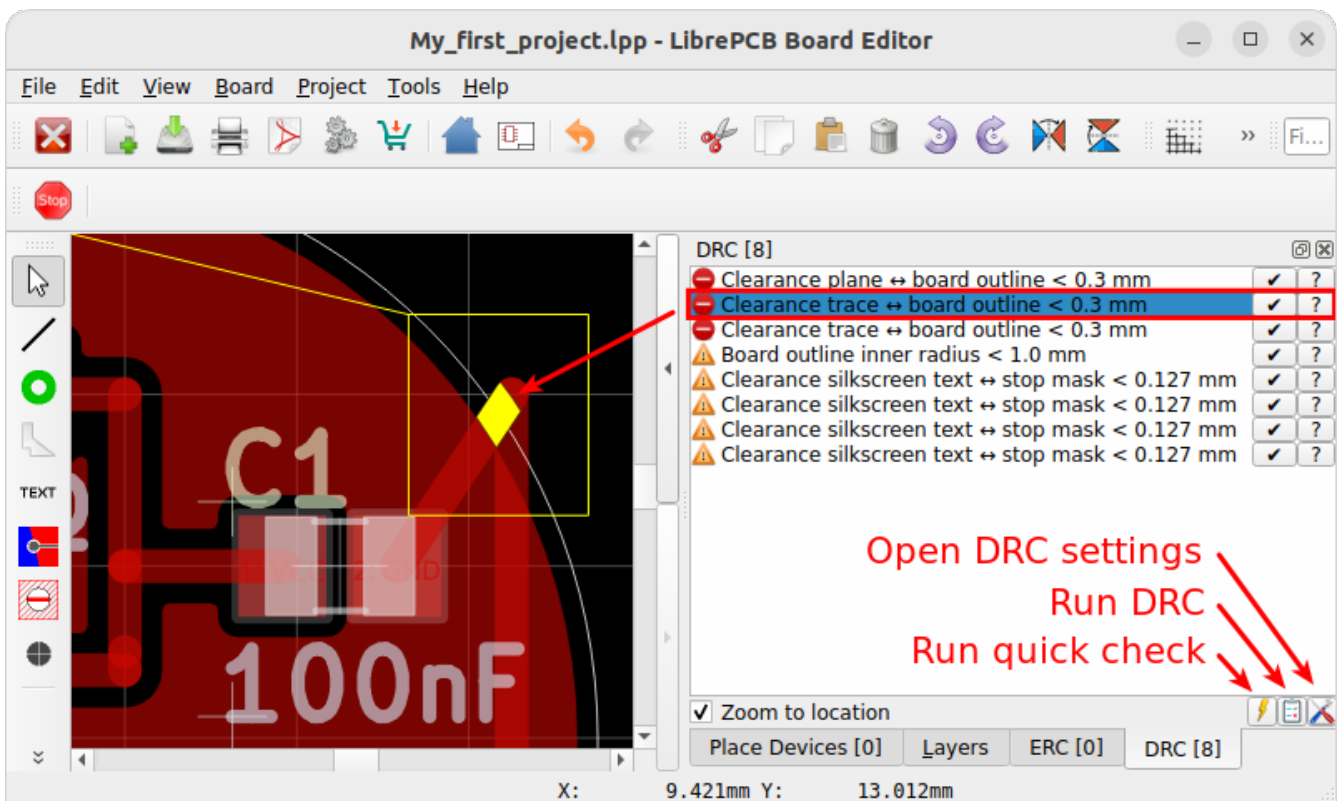

Then just click on a message to highlight the issue in the board editor. Or click on [?] to get some more information about a message. If you're sure a message is not relevant, you could approve it with [] but usually warnings/errors should be fixed instead of approved.



There's also a tool named **Quick Check** which runs only the most important checks of the DRC. It is intended to be run regularly while working on the layout and can be triggered with `Shift + F8`.

3D Preview

Once you fixed all ERC issues, it's highly recommended to review the PCB in the 3D viewer. If anything with the board outline, the device placement or something like that is not correct, chances are high you will notice that in the 3D view. Click on **View > Toggle 2D/3D Mode** or press `Ctrl + 3` to open it (press it two times for fullscreen):

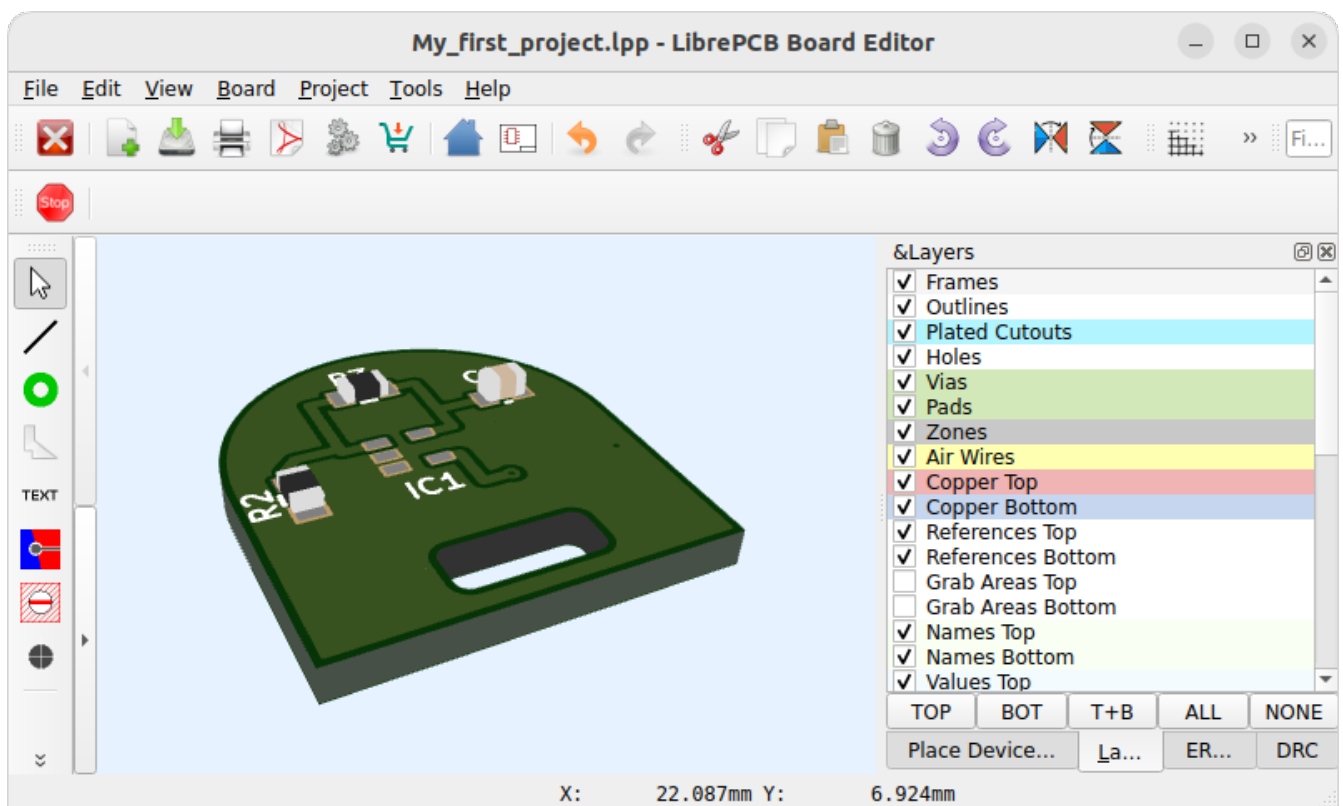

Note that not all packages have a 3D model assigned, like the OpAmp in our example. But no worries, this does not cause any issues.

If everything looks as expected, you're ready to order the PCB!

Order PCB

The easiest and fastest way to order the PCB is [LibrePCB Fab](https://fab.librepcb.org). It automatically exports and uploads all the necessary production data files without annoying you with the whole traditional production data workflow. See fab.librepcb.org/about for more information.



You prefer to manually generate the production data files? Or you want to use a PCB manufacturer not available at [LibrePCB Fab](https://fab.librepcb.org)? No problem! Just skip this

section and go to [Generate Production Data](#).

LibrePCB Fab

To start the order process, click the [**Order PCB**] toolbutton in either the schematic- or board editor:

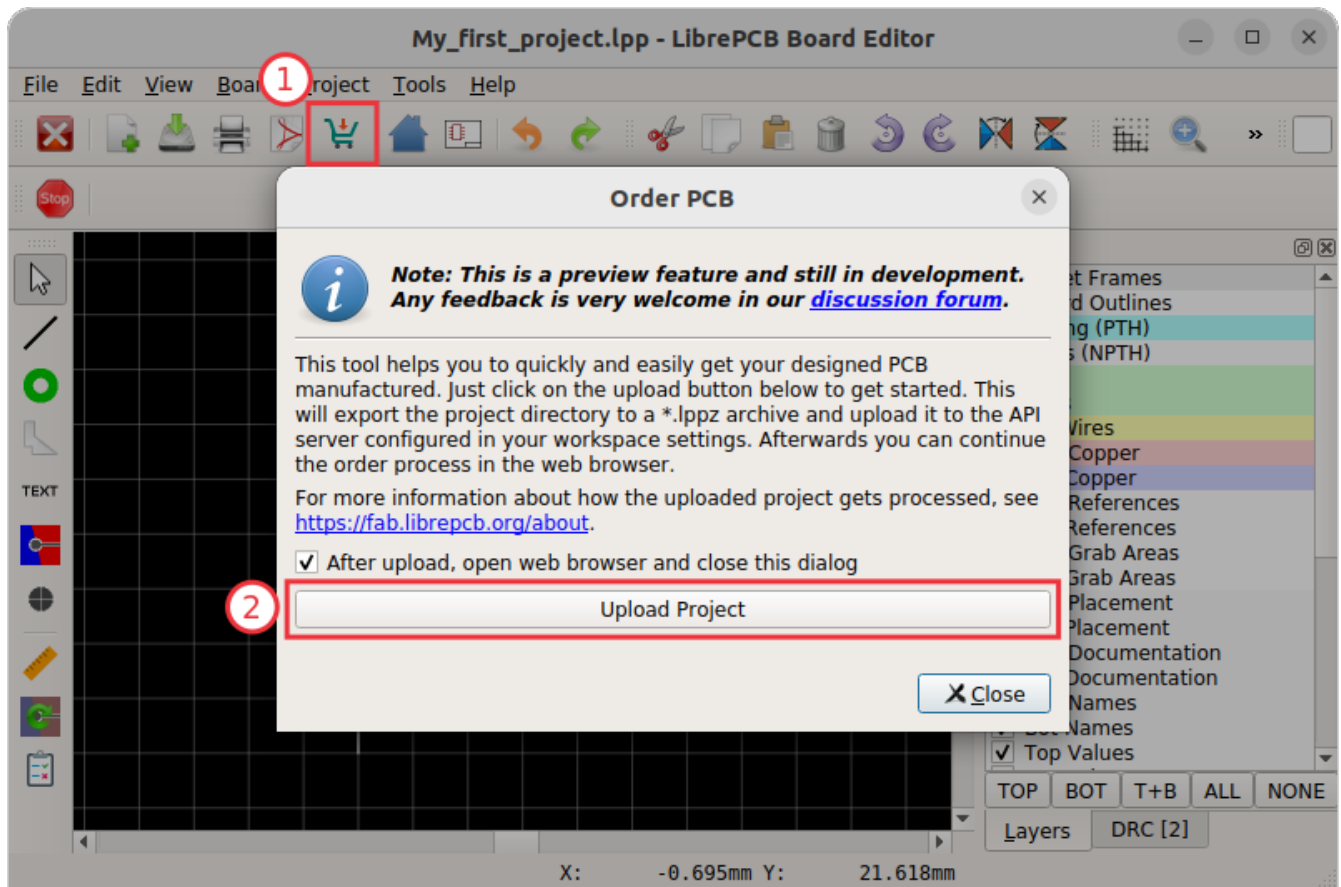

With [**Upload Project**], the project is uploaded to our order service fab.librepcb.org. Then your web browser should open a website where you can review and continue the order.



Alternatively you could also export your LibrePCB project as a ***.lppz** archive (**File** > **Export** > **Export *.lppz Archive**) and then upload this file with the web browser on fab.librepcb.org. This procedure might be useful if for some reason the direct upload is not desired or doesn't work (e.g. due to a corporate firewall).

Generate Production Data

Instead of using [LibrePCB Fab](#), of course you can also generate the production data manually and forward these files to any PCB manufacturer you like.

Currently there exist multiple ways how to generate production data, but it's recommended to use the **Output Jobs** feature for that. Click on **File** > **Output Jobs** or press **F11** to open the corresponding window:

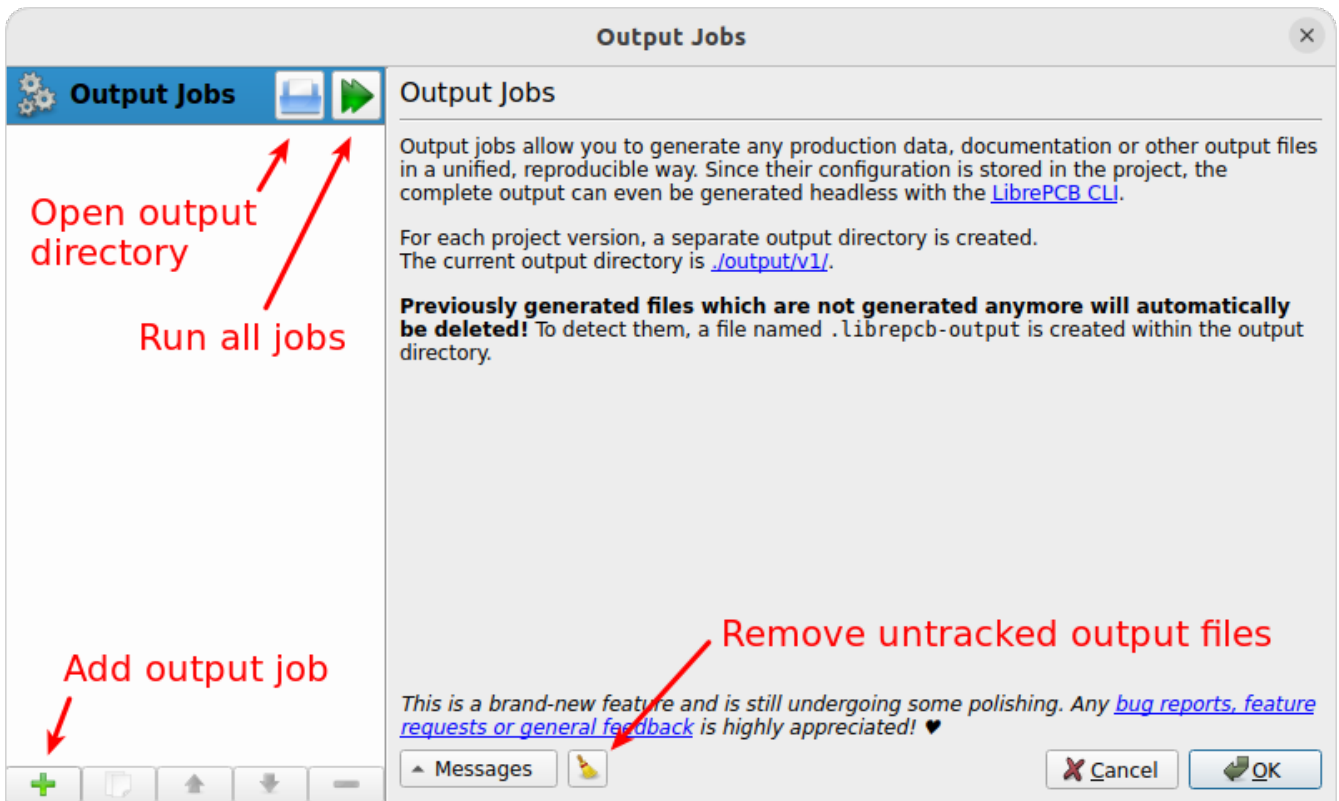

Then for any output you like to generate, click on the [+] button at the bottom left. See the following sections for details on the available jobs.



Any files generated through output jobs will be written to the path `./output/<VERSION>/` within the project directory, where `<VERSION>` is the project's version number as defined in the **Project Setup** dialog. So make sure the version number is set as desired to avoid overwriting e.g. the output files of a previous PCB version.

Once you set up all output jobs, just click on the "Run all jobs" button and all files will be written to the output directory. Then click on [OK] and save the project to store the output jobs configuration.

Gerber/Excellon

For the Gerber/Excellon production data you need to choose the settings of the Gerber/Excellon export. There are two different presets built-in, a default style and a Protel style. Generally you should determine what format your PCB manufacturer accepts. Many manufacturers accept Protel-style settings, so if you're unsure, choose **Gerber/Excellon (Protel Style)**.

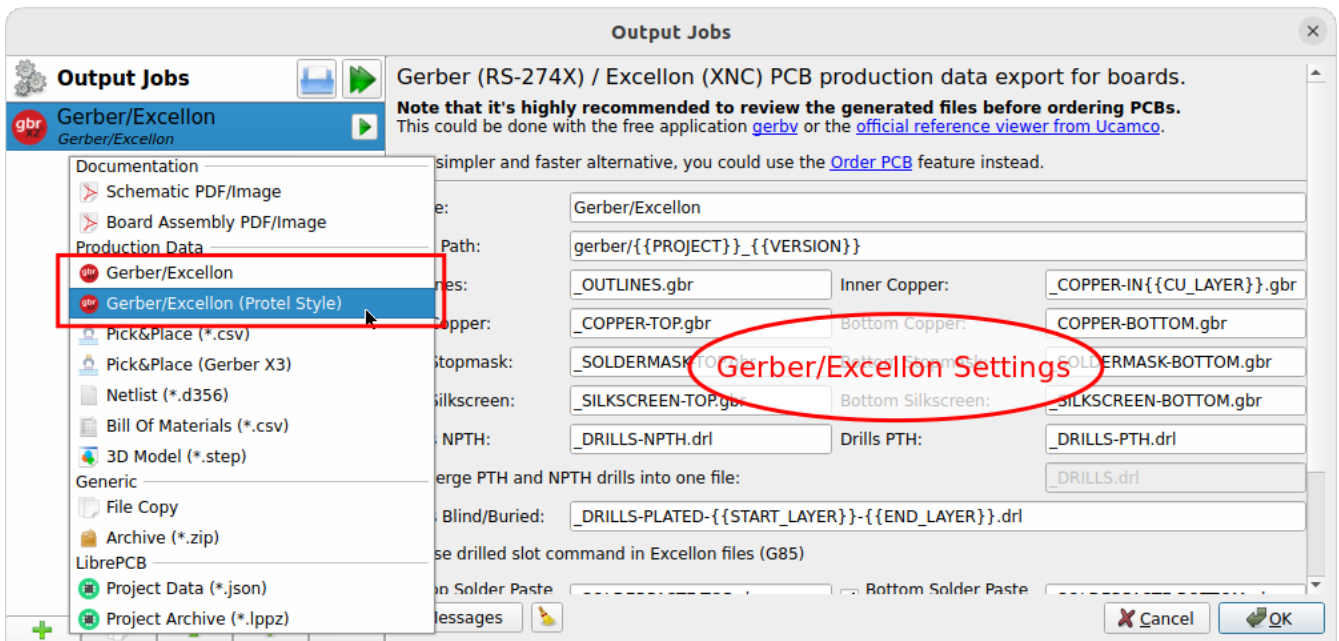

If required, the settings can now be adjusted manually.



It's highly recommended to cross-check the generated files with third-party tools like [gerbv](#) or [the reference Gerber viewer](#). LibrePCB developers are not responsible for any implications caused by wrong production data.

Pick&Place Data

If you also need pick&place files for automated assembly, just choose **Pick&Place (*.csv)** (or alternatively their Gerber X3 variant):

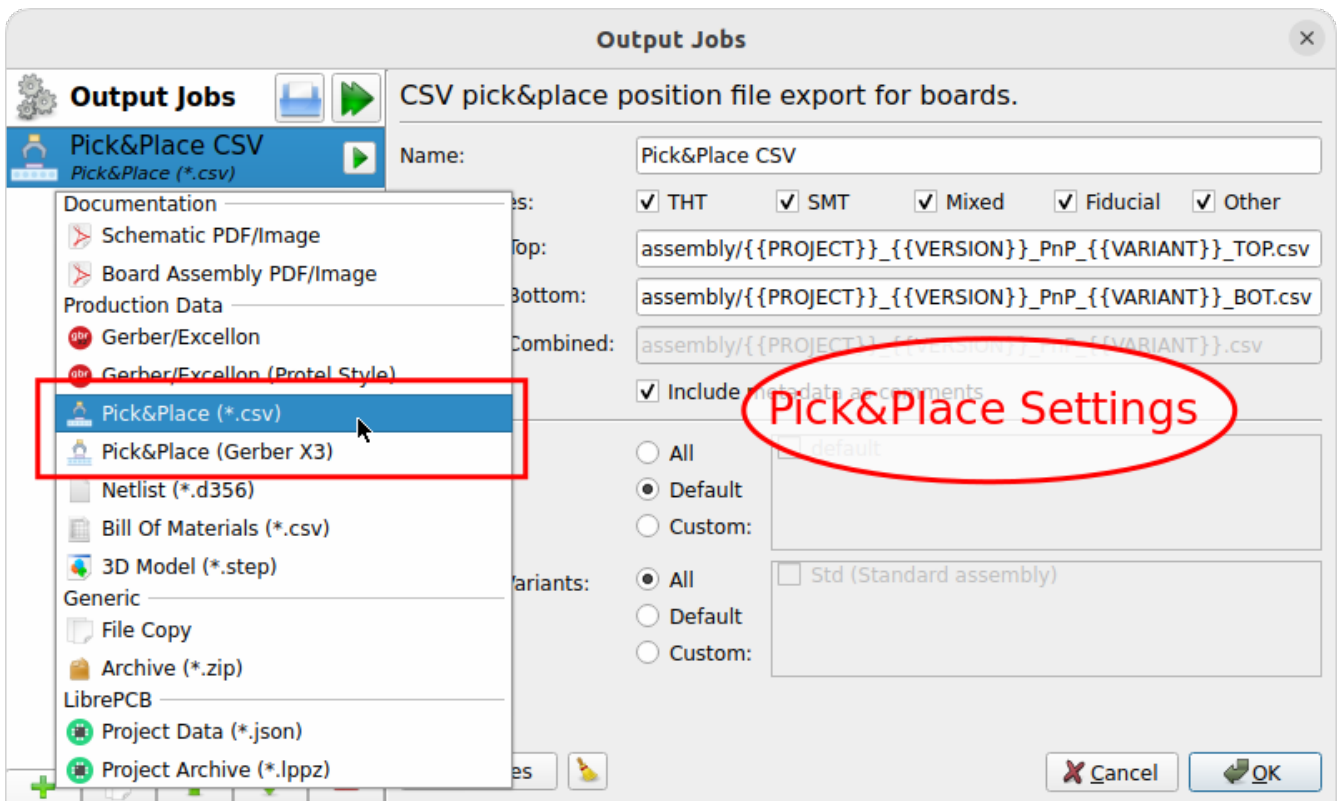

Bill of Materials

To get a bill of materials (BOM), add the output job **Bill Of Materials (*.csv)**:

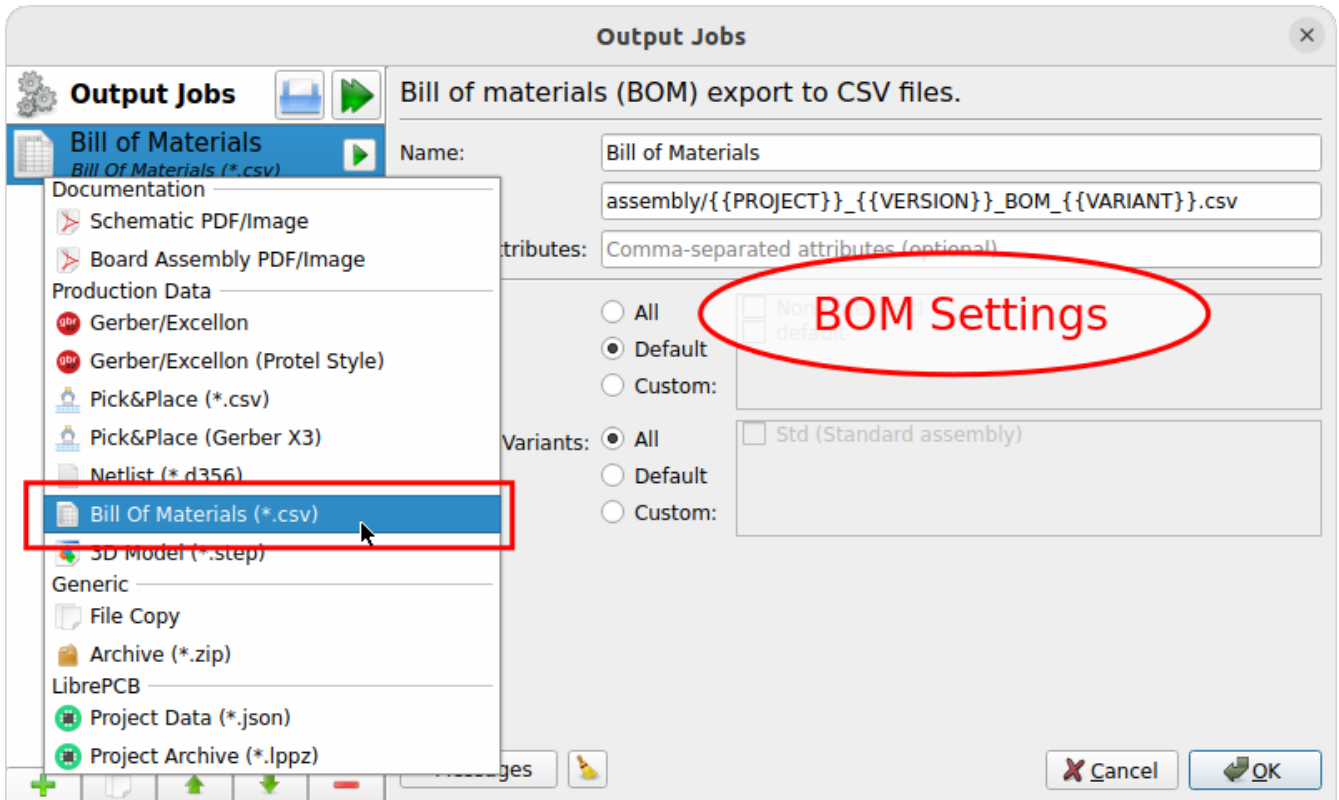

Create Library Elements

Sooner or later you'll need to create your own library elements in your local library you have created [previously](#). Open that library in the library manager:

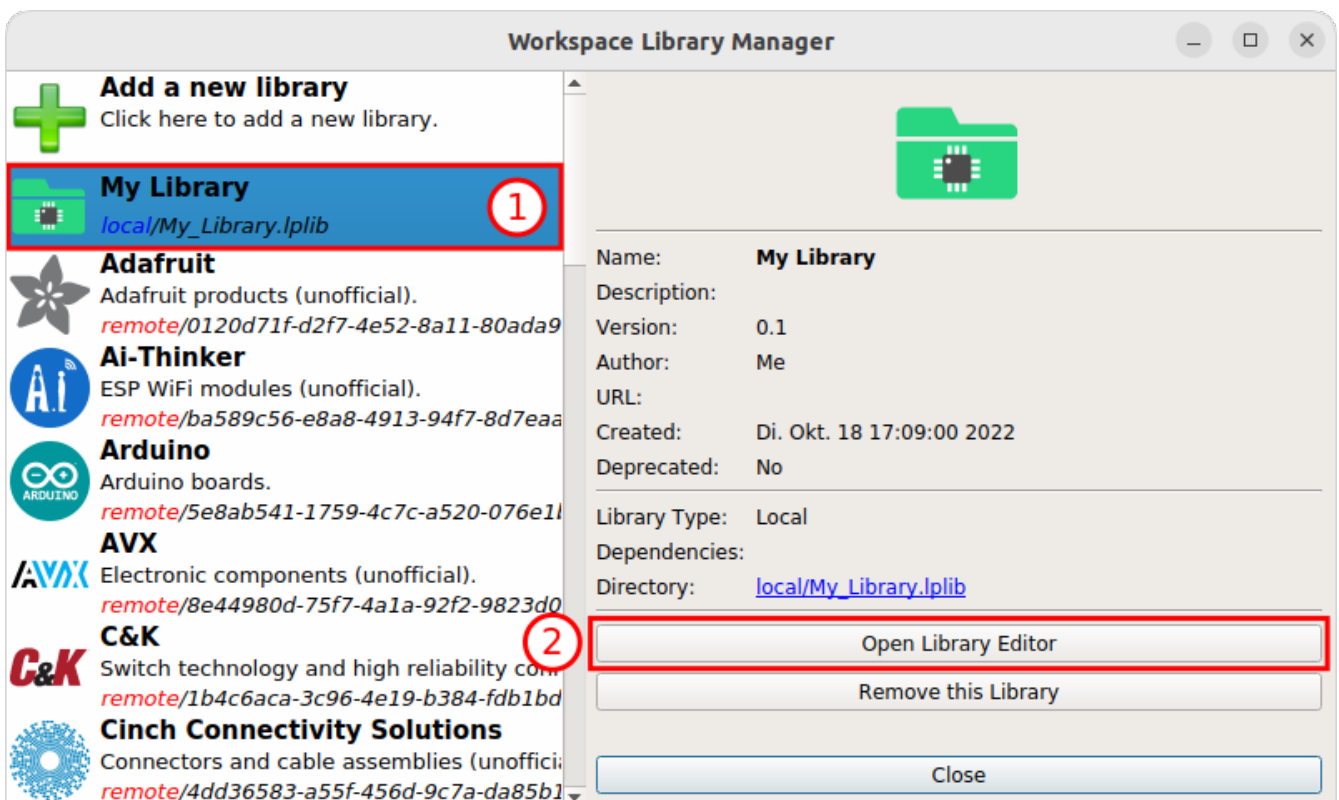

The [**New Library Element**] toolbutton (or **Ctrl + N**) in the library editor is the entry point for every new library element. There you can choose what kind of library element you want to create:

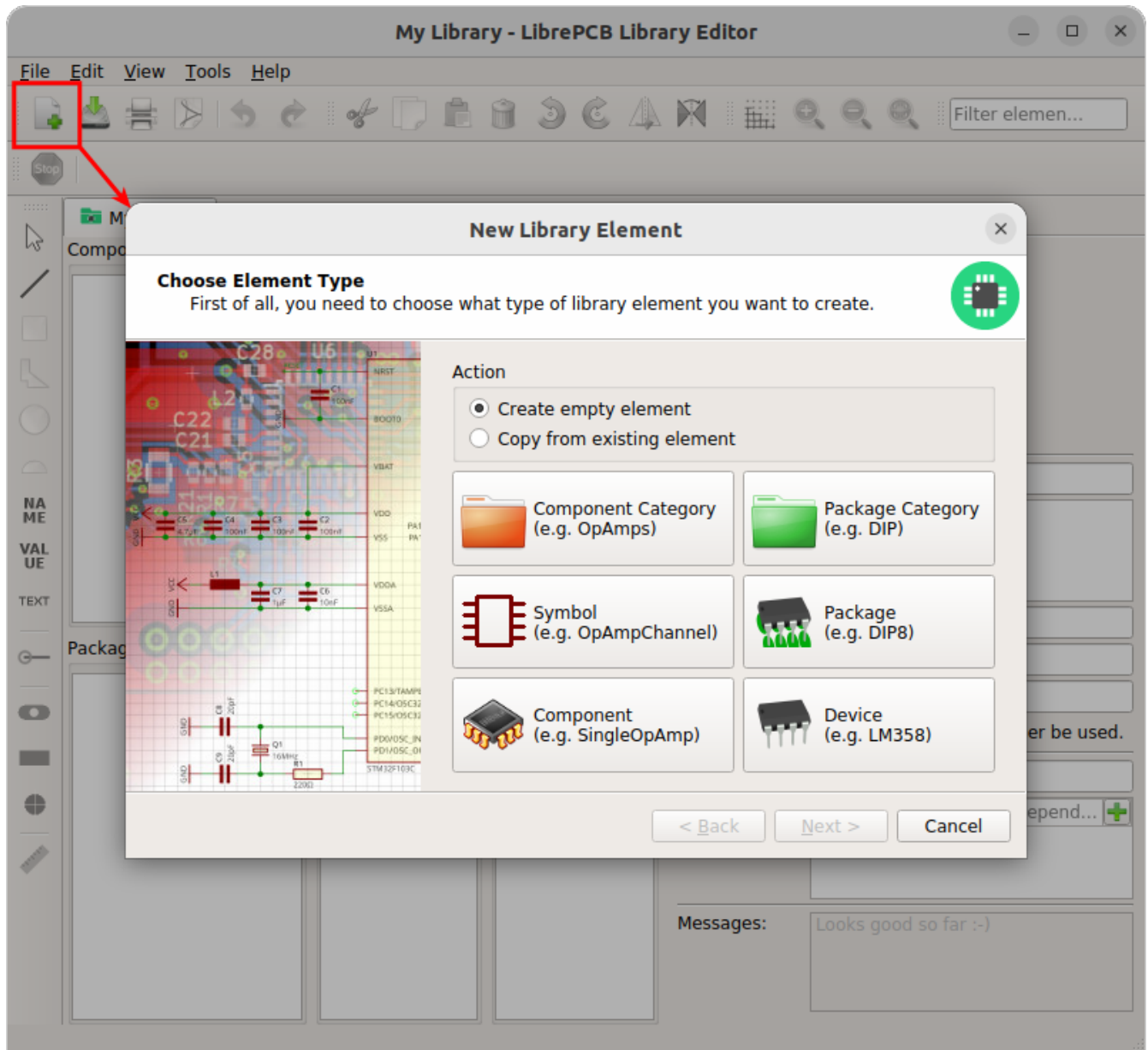

Concept Overview

But first we need a crash course to understand the basics of LibrePCB's library concept. A library consists of several different elements:

Component Category

These are basically "metadata-only" elements used to categorize the "real" library elements in a category tree. Every symbol, component and device can be assigned to one or more categories to make them browsable in the category tree you used in the schematic editor for [adding components/devices](#). Examples: *Resistors*, *LEDs*, *Microcontrollers*

Symbol

A symbol is the graphical representation of a component (or parts of it) in a schematic. It consists of electrical pins and graphical objects like lines. Examples: *European Resistor*, *LED*, *1x10 Connector*

Component

A component basically represents a "generic" kind of electrical part. It's **not** a real part which you can buy, it's just theoretical. The component defines the electrical interface of a part and how it is represented in the schematic (by referencing one or more symbols). But it does not define how the part looks physically on a board. Examples: *Resistor*, *Bipolar Capacitor*, *4-channel OpAmp*

Package Category

Exactly the same as the component category, but for packages instead of components. This allows to browse packages in a category tree. Examples: *Chip Resistors*, *Axial Capacitors*, *DIP*

Package

As the name suggests, packages represent the mechanical part of a "real" electronic part. It contains the footprint with their electrical pads and graphical objects which is then added to boards. Later a package may also contain a 3D model for the 3D board viewer. Examples: *TO220*, *DIP20*, *LQFP32*

Device

The device now represents a real electronic part which you can buy. It basically combines a component with a package and defines the pinout to connect component signals with package pads. Examples: *0805 Resistor*, *LM358D*, *STM32F103C*



The order of this list is also the order to follow when creating new library elements. For example a device always needs to be created **after** the corresponding component. The other direction is not possible because of the dependencies.

No worries if this is a bit too much theory for now. The rest of the tutorial is more practical, which will help you to understand the concept step by step.

Our Example: LMV321LILT

Let's say you want to create the part **LMV321LILT** (OpAmp, see [datasheet](#)) from A to Z. We will now create all the necessary library elements for the LMV321LILT, though in practice you only need to create the elements which do not exist already. You can even use elements from other libraries, for example the symbol from library X, the component from library Y and the package from library Z.



It's really important to understand how to re-use already existing components and packages. In many cases, your desired component (e.g. *Single OpAmp*) and package (e.g. *SOT23-5*) already exist in our libraries. **Then the only element you have to create is the device, which just takes a minute.**

If you want to learn the whole concept, follow the tutorial (recommended). If you only want to create a device, skip the basics and go directly to the [device tutorial](#).

Here an overview which library elements we'll create for the LMV321LILT:

- **Component category:** *Integrated Circuits › Linear › Amplifiers*

- **Symbol:** *Single OpAmp*
- **Component:** *Single OpAmp*
- **Package category:** *SOT*
- **Package:** *SOT23-5*
- **Device:** *LMV321LILT*

Component Category

First you should create a component category for the LMV321LILT (if it doesn't exist already). Open **New Library Element** > **Component Category**, choose a suitable (generic!) name and select a parent category. **You may first need to create the required parent categories.**



Creating component categories is optional. Everything works even without creating such categories so if you're in a hurry, just skip this step. However, categories help to keep your libraries organized and to quickly find components in the schematic editor.

In our example, we choose the following properties (any other metadata is optional):

- **Name:** *Amplifiers* (since the LMV321LILT is an amplifier)
- **Parent:** *Integrated Circuits* > *Linear* (let's assume these categories exist already)



If you're unsure about the category name, take a look at the navigation trees of [digikey.com](https://www.digikey.com) or [mouser.com](https://www.mouser.com) for inspiration. But don't use a nesting level higher than 3 levels (usually 2 levels are enough).

New Library Element ✕

Enter Metadata
 Please specify some metadata about the new element.

Name:	Amplifiers
Description:	
Keywords:	Comma separated list of keywords (en_US, optional)
Author:	Me
Version:	0.1
Category:	Root category ⇒ Integrated Circuits ⇒ Linear ... ↻

< Back
Finish
Cancel

After clicking on **[Finish]**, your first component category is already complete! It may just take a

moment for the background library scan until the new component category appears in the category trees.

▼ *Component categories available in the LibrePCB Base library*

<ul style="list-style-type: none"> ▼ Connectors <ul style="list-style-type: none"> Card Edge Connectors Coaxial Connectors Computer Connectors (USB, HDMI, Ethernet, ...) D-Sub Connectors Direct Wire to Board Connectors Flex Connectors Pin Headers (Male) Pin Sockets (Female) Terminal Blocks ▼ Discrete Semiconductors <ul style="list-style-type: none"> Diodes, Rectifiers Transistors, Thyristors ▼ Electromechanical <ul style="list-style-type: none"> Battery Holders Board Spacers Card Slots Fuse Holders IC Sockets Motors, Actuators Relays Switches 	<ul style="list-style-type: none"> ▼ Integrated Circuits <ul style="list-style-type: none"> ▼ Clock, Timing <ul style="list-style-type: none"> Clock Generators, PLLs, Frequency Synthesizers Real Time Clocks (RTC) Timers, Oscillators ▼ Data Acquisition <ul style="list-style-type: none"> Analog Front End (AFE) Analog to Digital Converters (ADC) Digital Potentiometers Digital to Analog Converters (DAC) ▼ Data Processing <ul style="list-style-type: none"> Complex Programmable Logic Devices (CPLD) Digital Signal Processors (DSP) Field Programmable Gate Arrays (FPGA) Microcontrollers, Microprocessors Programmable Logic Devices (PLD) Systems On Chip (SoC) ▼ Interface <ul style="list-style-type: none"> Analog Switches, Multiplexers, Demultiplexers Drivers, Receivers, Transmitters Signal Buffers, Repeaters, Splitters USB Interfaces Isolators ▼ Linear <ul style="list-style-type: none"> Amplifiers Comparators ▼ Logic <ul style="list-style-type: none"> Buffers, Drivers Counters, Dividers Flip Flops, Latches Gates, Inverters Shift Registers Signal Switches, Multiplexers, Decoders Translators, Level Shifters Memory ▼ Power Management (PMIC) <ul style="list-style-type: none"> AC/DC Converters Battery Chargers Battery Management Full/Half Bridge Drivers Gate Drivers LED Drivers Motor Drivers/Controllers Supervisors Voltage References Voltage Regulators 	<ul style="list-style-type: none"> Miscellaneous <ul style="list-style-type: none"> ▼ Optoelectronics <ul style="list-style-type: none"> Displays LEDs Nixie Tubes Optocouplers ▼ Passive <ul style="list-style-type: none"> Capacitors Crystals, Oscillators, Resonators Inductors, Coils, Chokes, Filters Resistors ▼ Schematic Symbols <ul style="list-style-type: none"> Schematic Frames Supply Symbols ▼ Sensors, Transducers <ul style="list-style-type: none"> Current Transducers Encoders Gas Sensors Humidity Sensors Magnetic Sensors Motion Sensors Optical Sensors Particle and Dust Sensors Temperature Sensors Single Board Computers, Dev/Eval Boards
---	--	--

Symbol

Now we need to create a symbol for the OpAmp. Open **New Library Element** > **Symbol**, choose a name and the component category we just created and click [**Finish**]:

New Library Element ✕

Enter Metadata
Please specify some metadata about the new element. 

Name:

Description:

Keywords:

Author:

Version:

Category: ... ↻

Draw Polygons

Now let's draw the graphical objects of the symbol:

1. Choose a tool. There are several similar tools available, but often you need only the [**Draw Rectangle**] or the [**Draw Polygon**] tool.
2. Specify the polygon properties. **For the symbol's "body", choose the *Outlines* layer.** When checking *Grab Area*, you'll be able to drag the symbol in the schematic editor by clicking on the polygon's area.
3. Draw the polygon with the cursor.

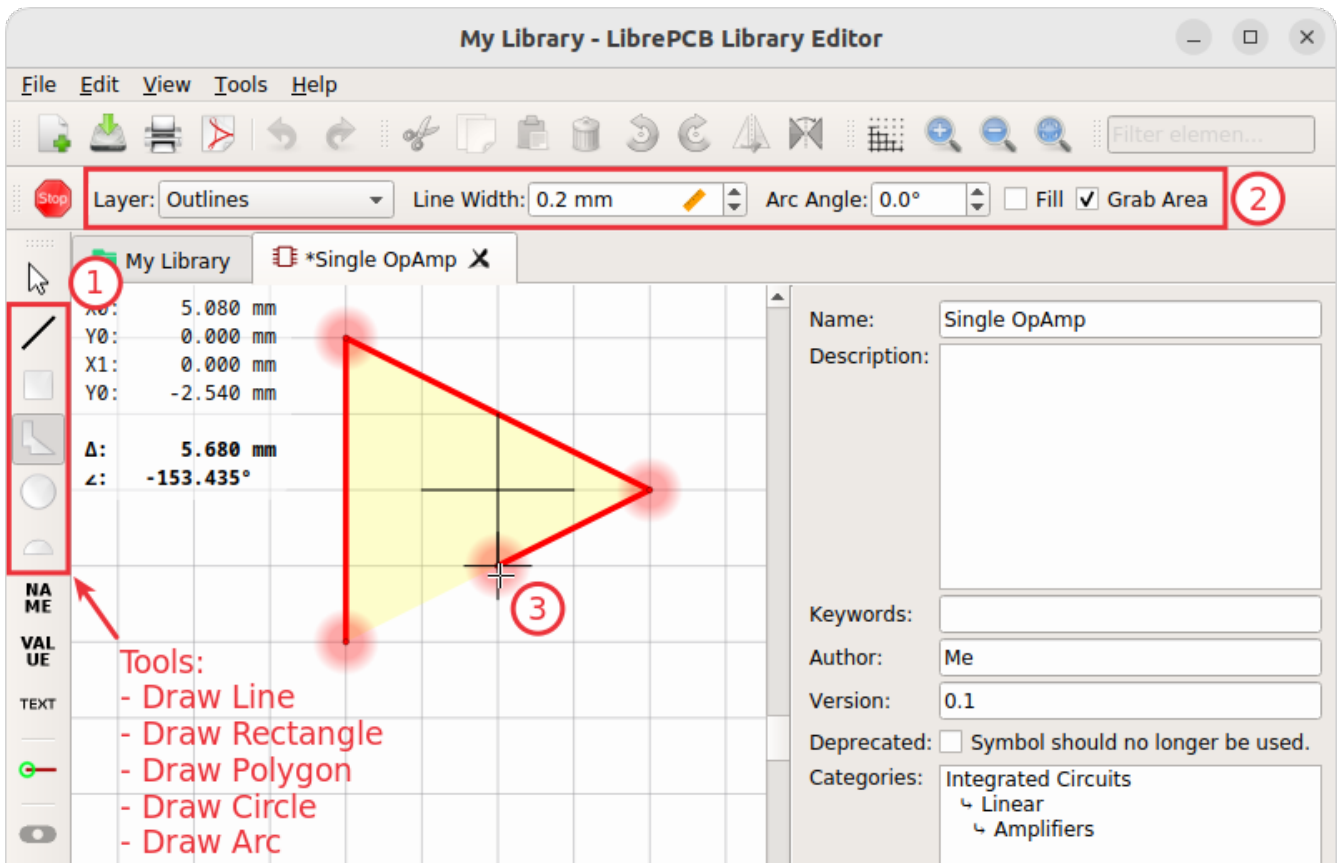

Add Texts

Then you should **add at least two text objects**:

- **Name:** Using the placeholder `{{NAME}}` which will be substituted by the component's designator (e.g. "R5") in the schematics.
- **Value:** Using the placeholder `{{VALUE}}` which will be substituted by the component's value (e.g. "100nF") in the schematics.

For convenience, there are dedicated tools for these two text objects. Use them as follows:

1. Start one of the text tools.
2. If needed, adjust the text properties in the toolbar.
3. Place the text object with a mouse click. Press `R` or `Right Click` to rotate or `M` to mirror the alignment while moving.

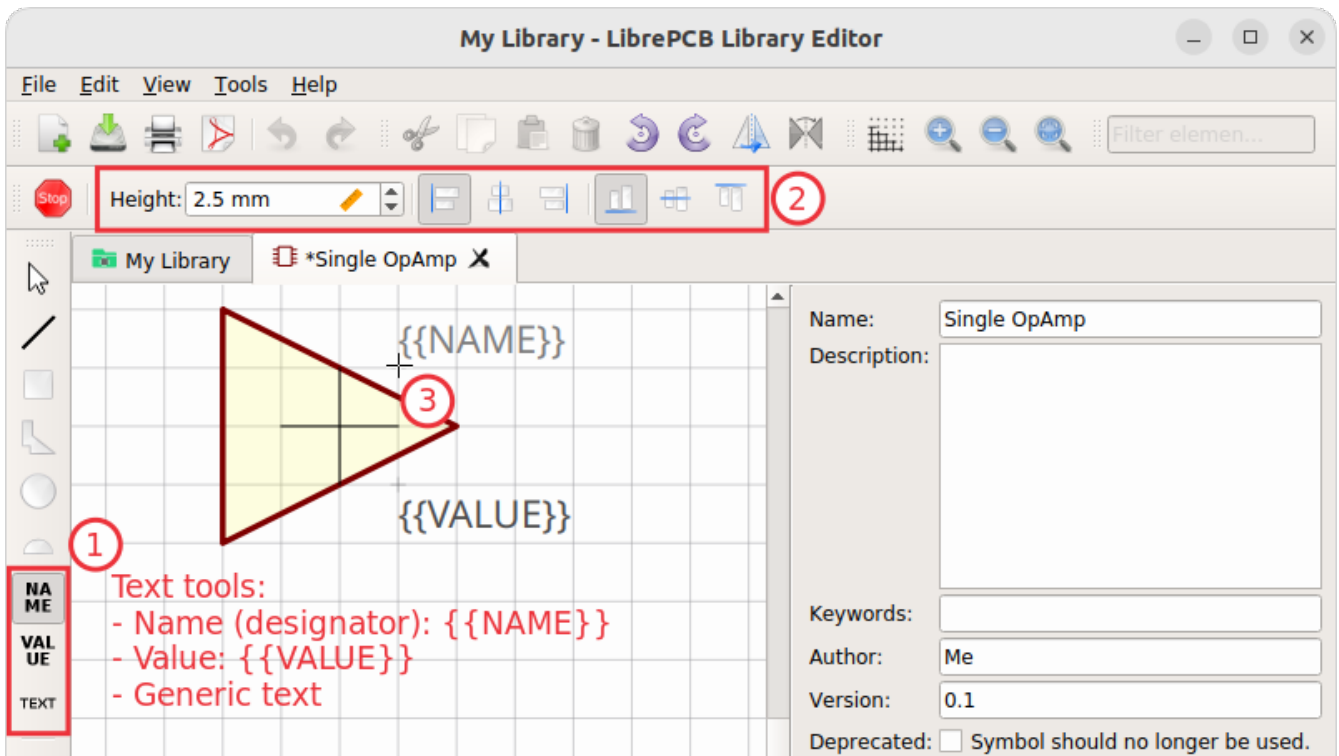

Add Pins

Then, the most important thing is to add pins since these are required later in the schematics to attach wires to the symbol.

1. Start the [**Add Pin**] tool.
2. Choose a reasonable (unique!) pin name and length. Press **Tab** to move the focus into the name input field.
3. Place the pin with a mouse click. Press **R** or **Right Click** to rotate while moving.

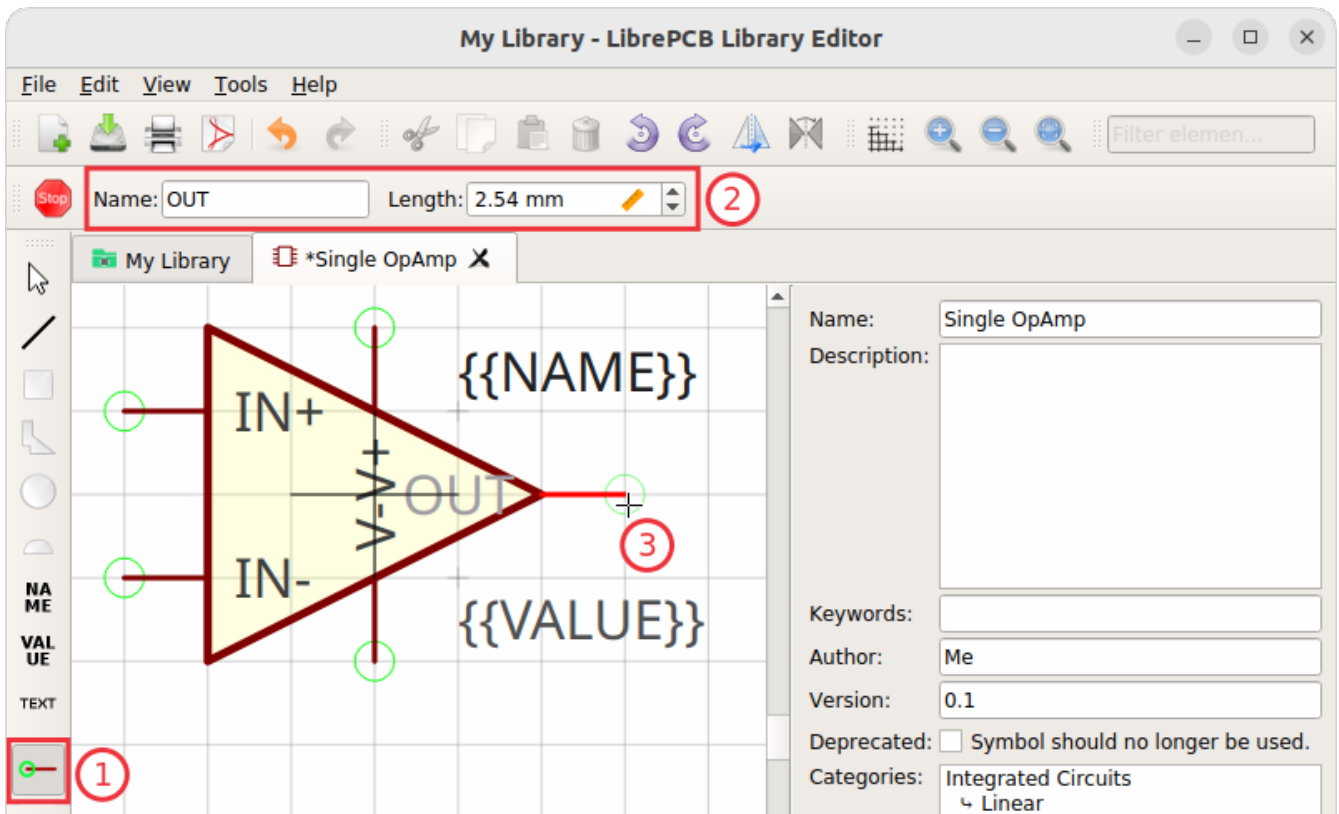

The overlapping pin texts look a bit ugly, but let's ignore that for the moment.



It's not possible to add multiple pins with the same name. If your device for example has multiple *GND* pads which are all connected together (i.e. you don't need to distinguish between them), add **only one** *GND* pin to the symbol. If you need to distinguish between the different pins, assign unique names (e.g. *GND_1*, *GND_2* etc.).

Now **save the symbol** to let the background scan picking up the new symbol (this takes a moment) before you can use this symbol in a component.

Recommendations

For details about how symbols should be designed, please take a look at our [symbol conventions](#). The most important rules are:

- For generic components, create generic symbols (e.g. *Diode* instead of *1N4007*).
- The origin (coordinate *0,0*) should be in (or close to) the center of the symbol.
- Pins must represent the *electrical* interface of a part, not the *mechanical*. So don't add multiple pins with the same function (e.g. *GND*) and don't name pins according to their location in the package. Name them according to their electrical purpose (e.g. *IN+*, *IN-*, *OUT*) instead, or just use incrementing numbers (i.e. *1*, *2*, *3*, ...).
- Pins should be grouped by functionality and placed on the 2.54mm grid.
- There should be text elements for `{{NAME}}` and `{{VALUE}}`.

Component

The next element you need to create is the component for a single OpAmp. Because it is still very generic (beside the LMV321LILT there are many other OpAmps with exactly the same functionality), you should enter a generic name like *Single OpAmp*.

Open **New Library Element > Component**, enter the name and assign the component category we created previously:

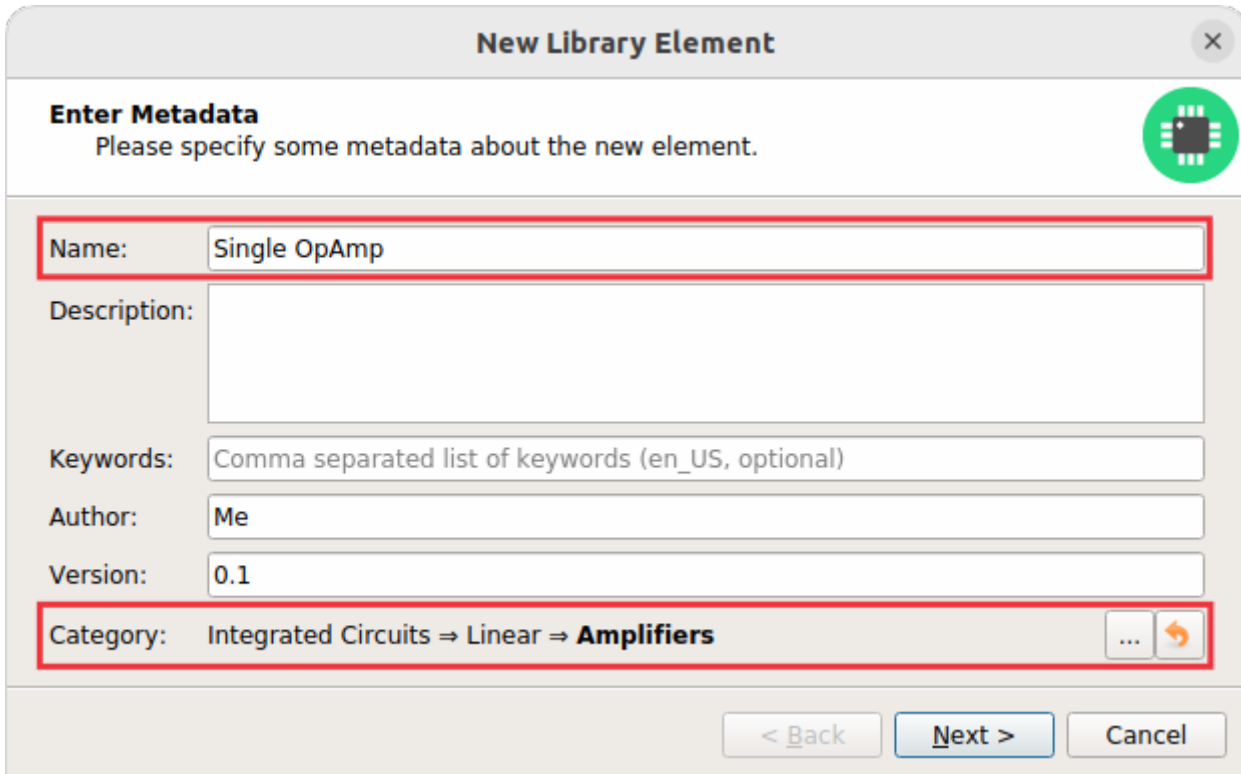

New Library Element

Enter Metadata
Please specify some metadata about the new element.

Name: Single OpAmp

Description:

Keywords: Comma separated list of keywords (en_US, optional)

Author: Me

Version: 0.1

Category: Integrated Circuits => Linear => **Amplifiers**

< Back Next > Cancel

Set Properties

After clicking on [**Next**] you're asked to specify some properties of the component:

Schematic-Only

Check this if the component must not appear on a board, but only in the schematics. This is typically used for schematic frames.

Prefix

When adding the component to a schematic, its name (designator) is automatically set to this value, followed by an incrementing number. So if you choose the prefix *R*, components added to a schematic will have the names *R1*, *R2*, *R3* and so on. The prefix should be very short and uppercase.

Default Value

In addition to the name, components also have a value assigned to it, which is typically also displayed in the schematic. For example a capacitor has its capacitance (e.g. *100nF*) set as its value. When adding a component to a schematic, its value is initially set to the value specified here. The value can also be a placeholder, for example `{{MPN}}`, `{{DEVICE}}` or `{{CAPACITANCE}}`. If you are unsure, just leave it empty, the component editor will help you to assign a value later.

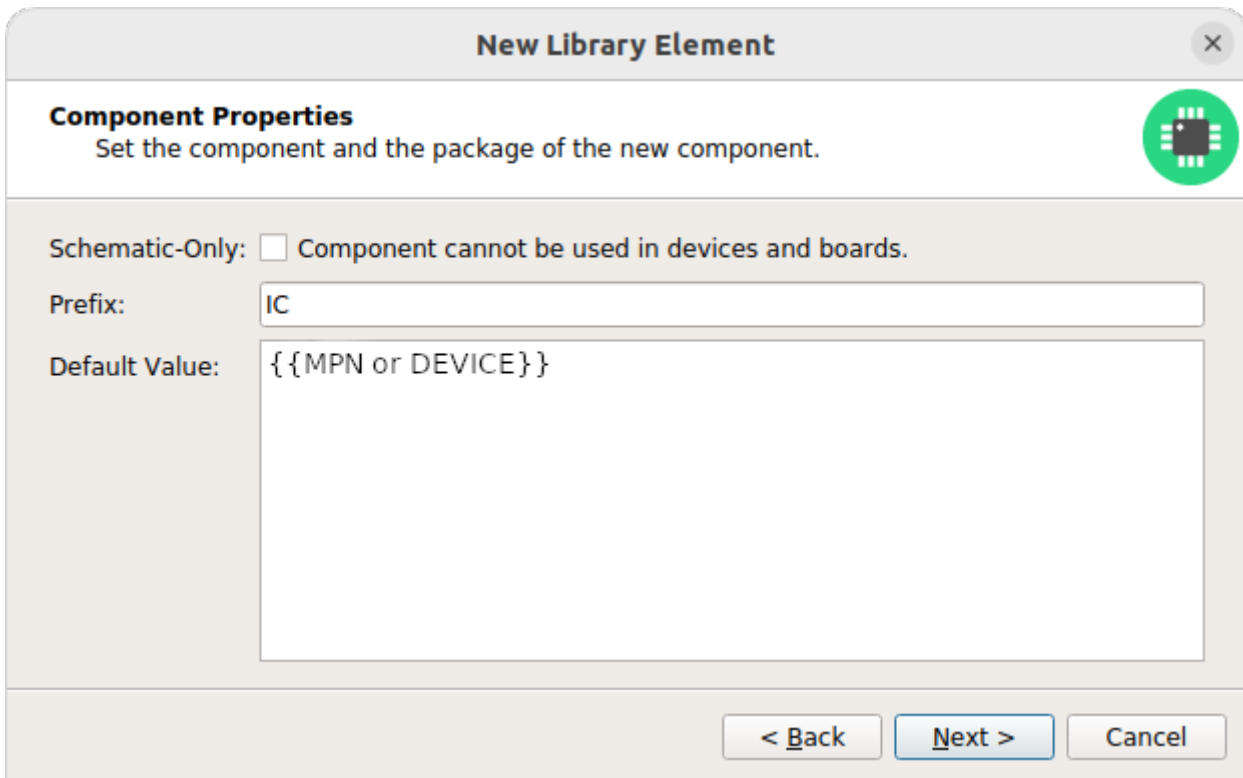

Add Symbols (aka *Gates*)

Now you need to choose the symbols which represent the component in schematics (also called *gates*). Most components have only one symbol, but you can also add more than one, for example an OpAmp could have separate symbols for power and amplifier. In our case, select the *Single OpAmp* symbol we created previously:

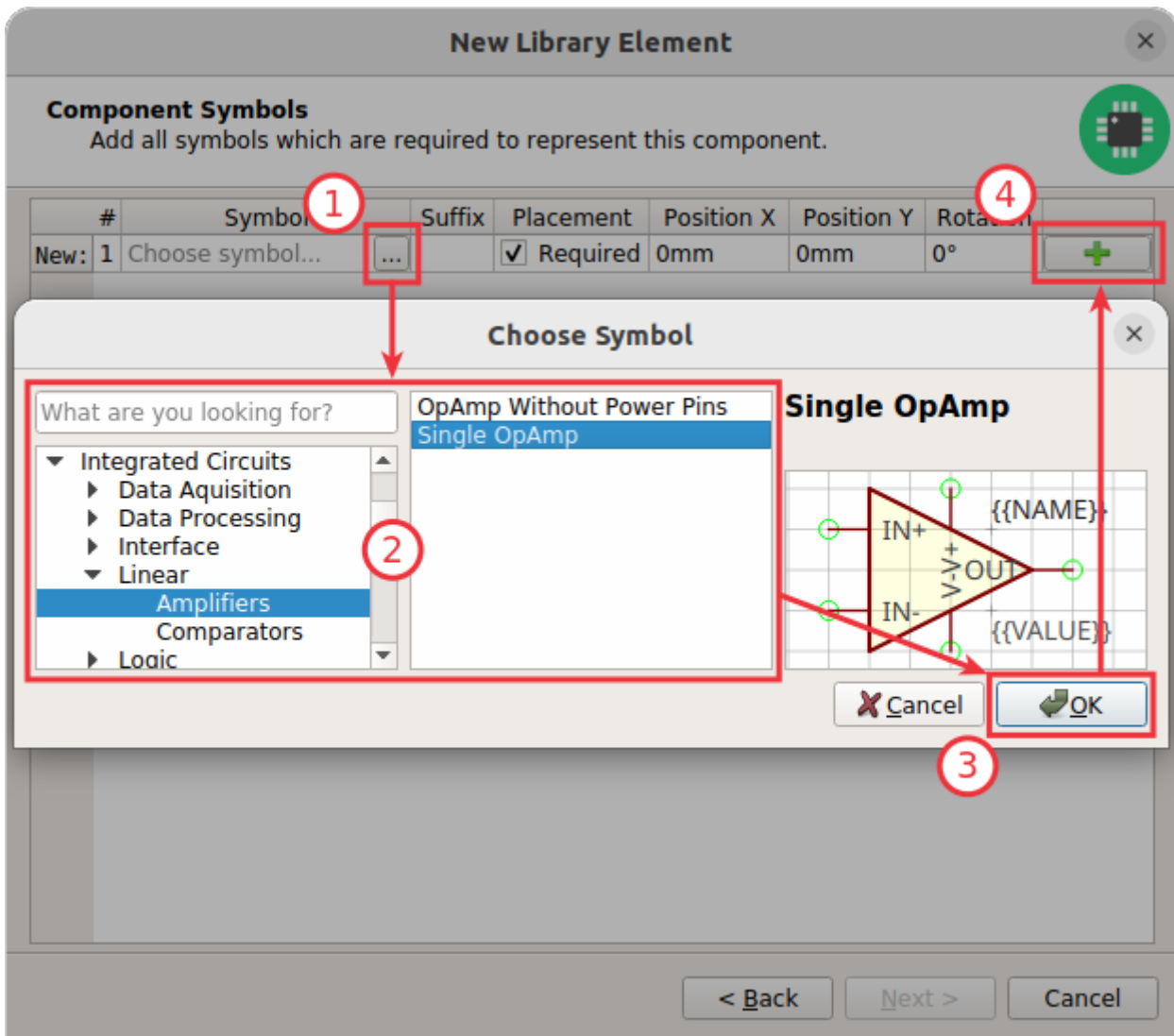

Don't forget to click on the [+] button after closing the symbol chooser dialog. Then click on [Next].

Add Signals

The next step is to define all so-called signals of a component. Signals represent the "electrical interface" of a component. For example a transistor consists of the signals *Base*, *Collector* and *Emitter*. For a component it's irrelevant whether the "real" transistor has multiple emitter pads, or an additional thermal pad and so on — the component only specifies the three electrical signals.

LibrePCB automatically extracts the signals from the pins of the specified symbols, so often you don't have to do this by hand. But sometimes you still should adjust the names or properties of these signals. For our OpAmp, we check the *Required* checkbox of all signals to ensure the ERC will raise a warning if these signals are not connected to a net in the schematics:

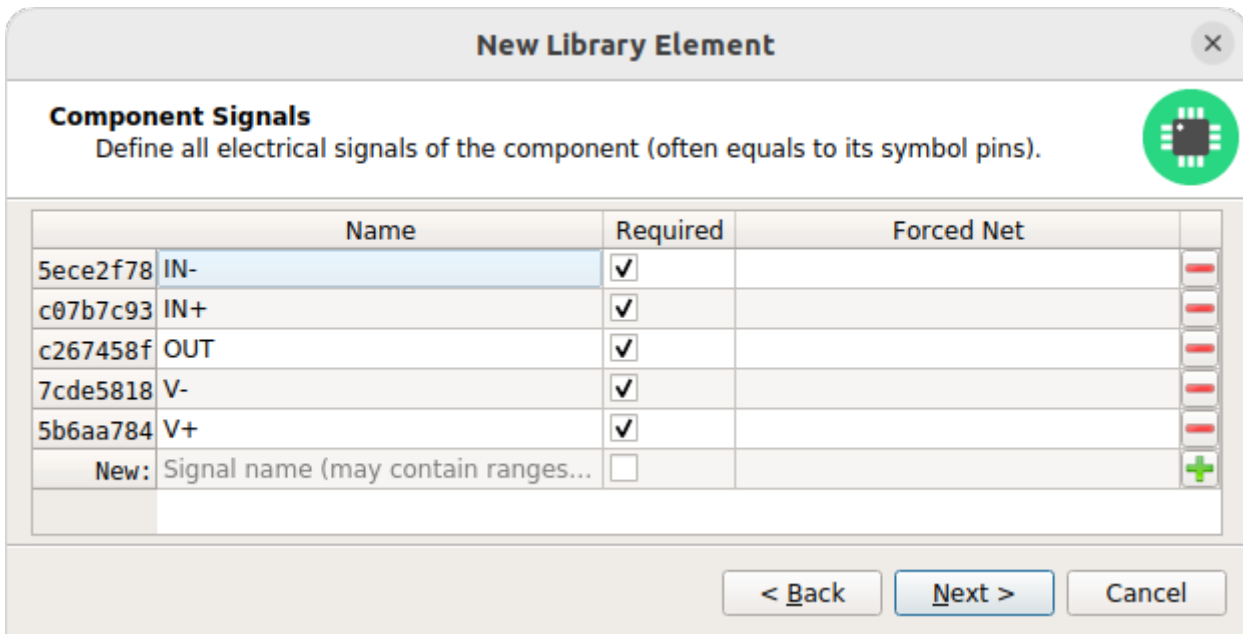

Connect Pins To Signals

These signals now need to be assigned to the corresponding symbol pins to create the connections. But since they were automatically generated from the pins, you can just click on [**Automatically assign all signals by name**]:

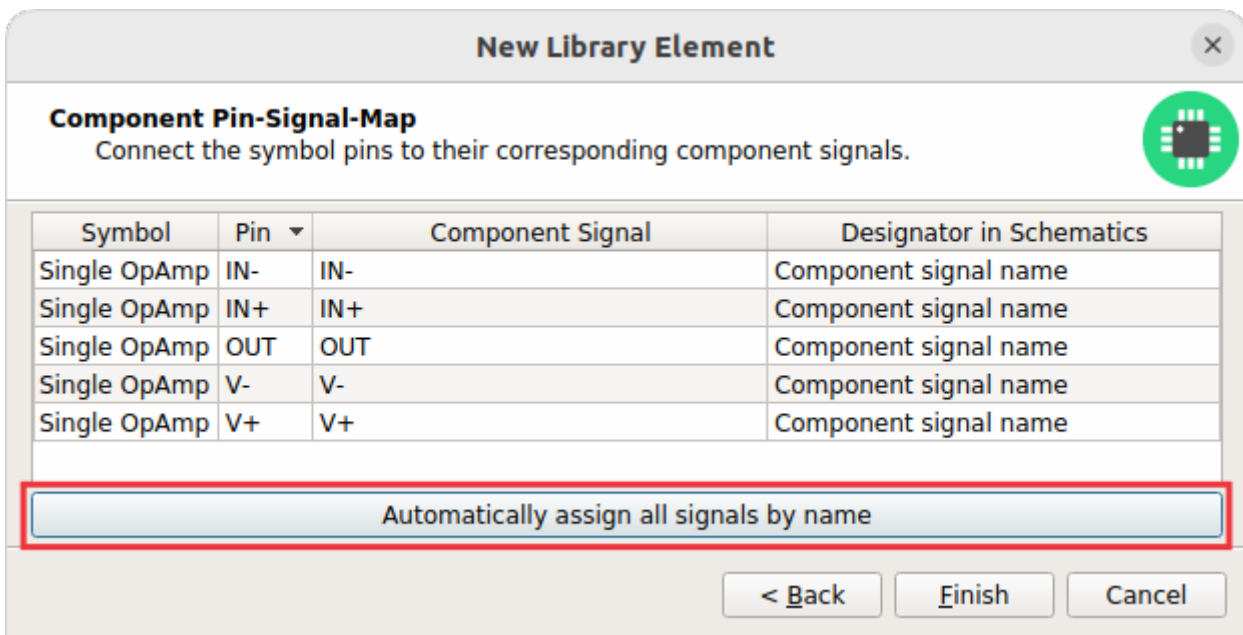

Component Editor

After clicking on [**Finish**], the component is complete:

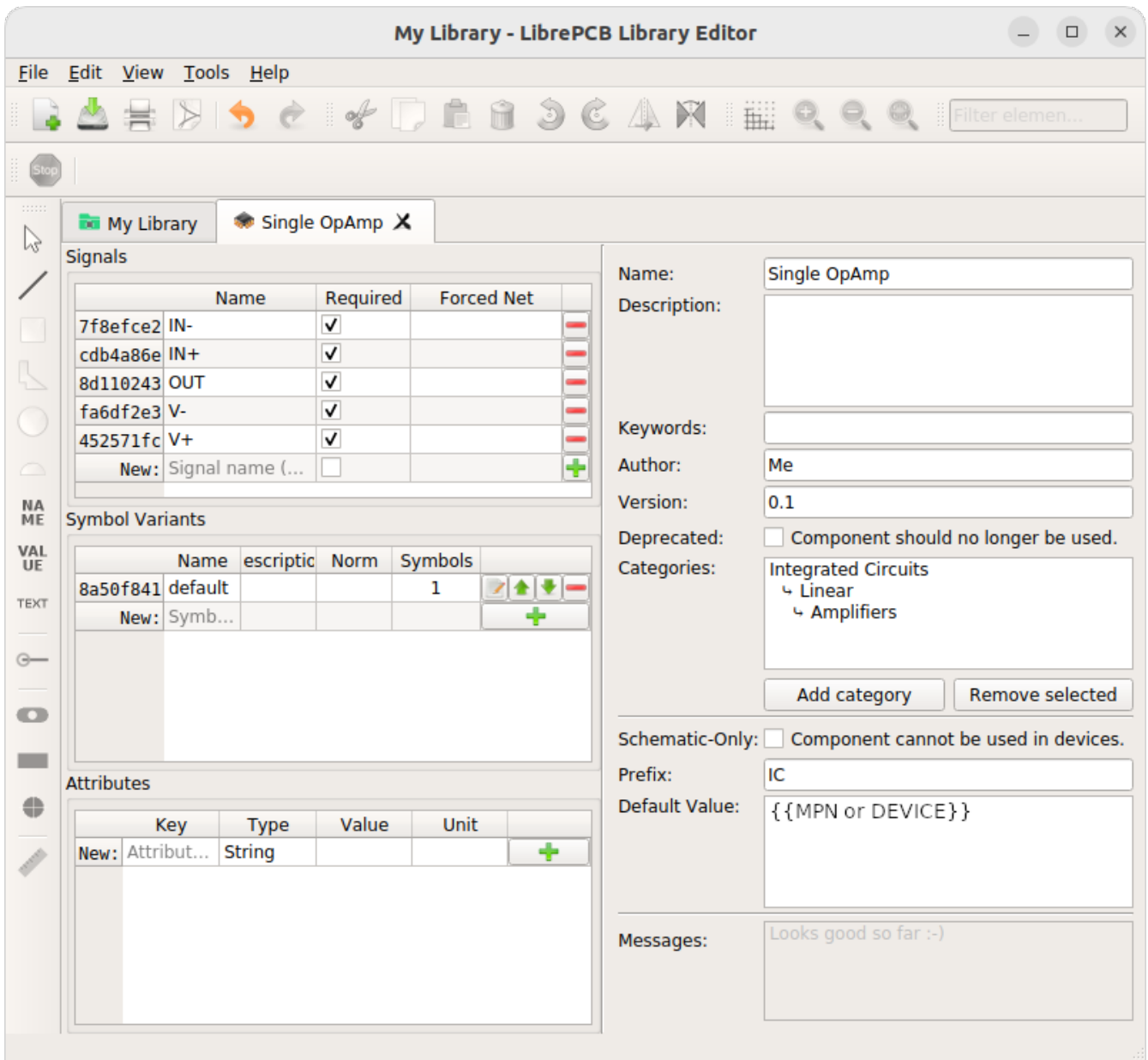

For our simple example this procedure might feel a bit complicated. This is due to the broad flexibility of the LibrePCB library approach which will save time in the long term due to high reusability of library elements.



The component which we created uses only very basic library features, but as soon as you understand the library concept in more detail, you will be able to easily create much more complicated library elements. We're sure you will learn to love the flexibility of the library concept step by step.

Recommendations

Following are the most important rules to create reusable components:

- Create generic components whenever possible. Only create specific components for manufacturer-specific parts (like microcontrollers).
- Generally name signals according their electrical purpose (e.g. *Source*, *Drain*, *Gate*).

- Don't add multiple signals which are considered as connected. Even for a microcontroller which has multiple *GND* pins, the component should have only one *GND* signal. Keep in mind that a component represents the *electrical* interface of a part, not the *mechanical*!

Package Category

Before creating a package for the LMV321LILT, you should (optionally) create a category for it. This is done exactly the same way as you already created the [component category](#).

Since we need to create a *SOT23-5* package, let's choose the following properties for its category:

- **Name:** *Small-Outline Transistor (SOT)*
- **Parent:** *Transistor* (let's assume this category exists already)

New Library Element

Enter Metadata
Please specify some metadata about the new element.

Name: Small-Outline Transistor (SOT)

Description:

Keywords: Comma separated list of keywords (en_US, optional)

Author: Me

Version: 0.1

Category: Root category => **Transistor**

< Back Finish Cancel

With a click on [**Finish**] the package category is complete and after a moment the new category is ready to use.

▼ *Package categories available in the LibrePCB Base library*

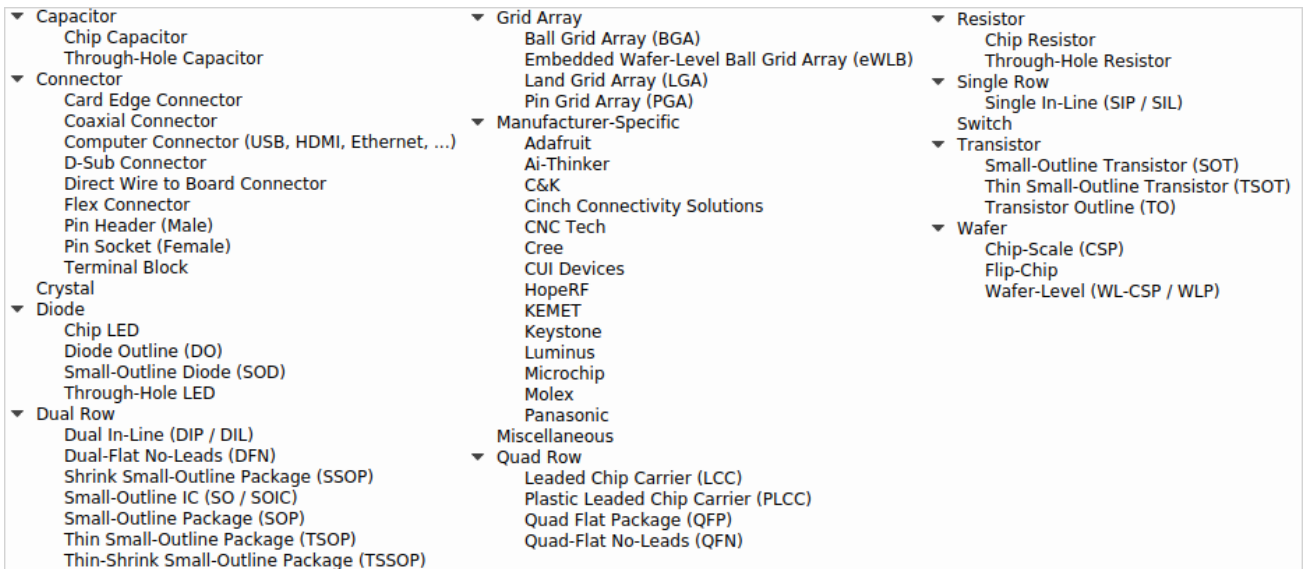

Package

Then you need to create the package for the LMV321LILT, which is called *SOT23-5*. As usual, open **New Library Element** > **Package** and specify the name and category:

Add Pads

Now you need to specify all pads of the package. The *SOT23-5* has 5 pads named from 1 to 5, so you can just enter the term *1..5* and click on the [+] button:

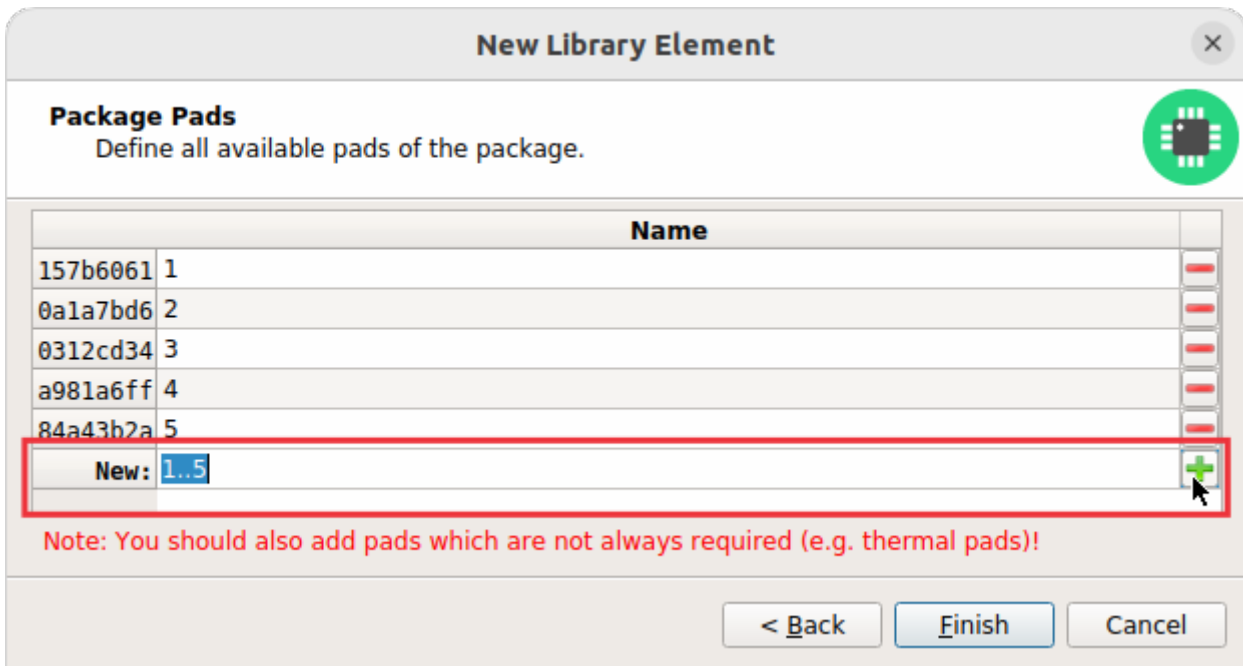

When adding the pads, don't consider their electrical functions or internal connections. For example if a transistor with three electrical signals has three pads plus a thermal pad connected to one of the other signals, the package has **four** pads in total. It's not relevant whether some of them are connected to each other *within* the package.

General rule of thumb: If in doubt, better specify too many pads than too few ;-)

Place Pads

After clicking on [**Finish**], you can draw the footprint. It's recommended to start with placing the pads:

1. Set a reasonable grid interval with the [**Grid Properties**] toolbutton.
2. Start either the [**Add THT Pad**] or [**Add SMT Pad**] tool.
3. Choose the package pad to place and specify its properties, most notably the shape and size.
4. Place the pad with a click. Press **R** to rotate it while moving.

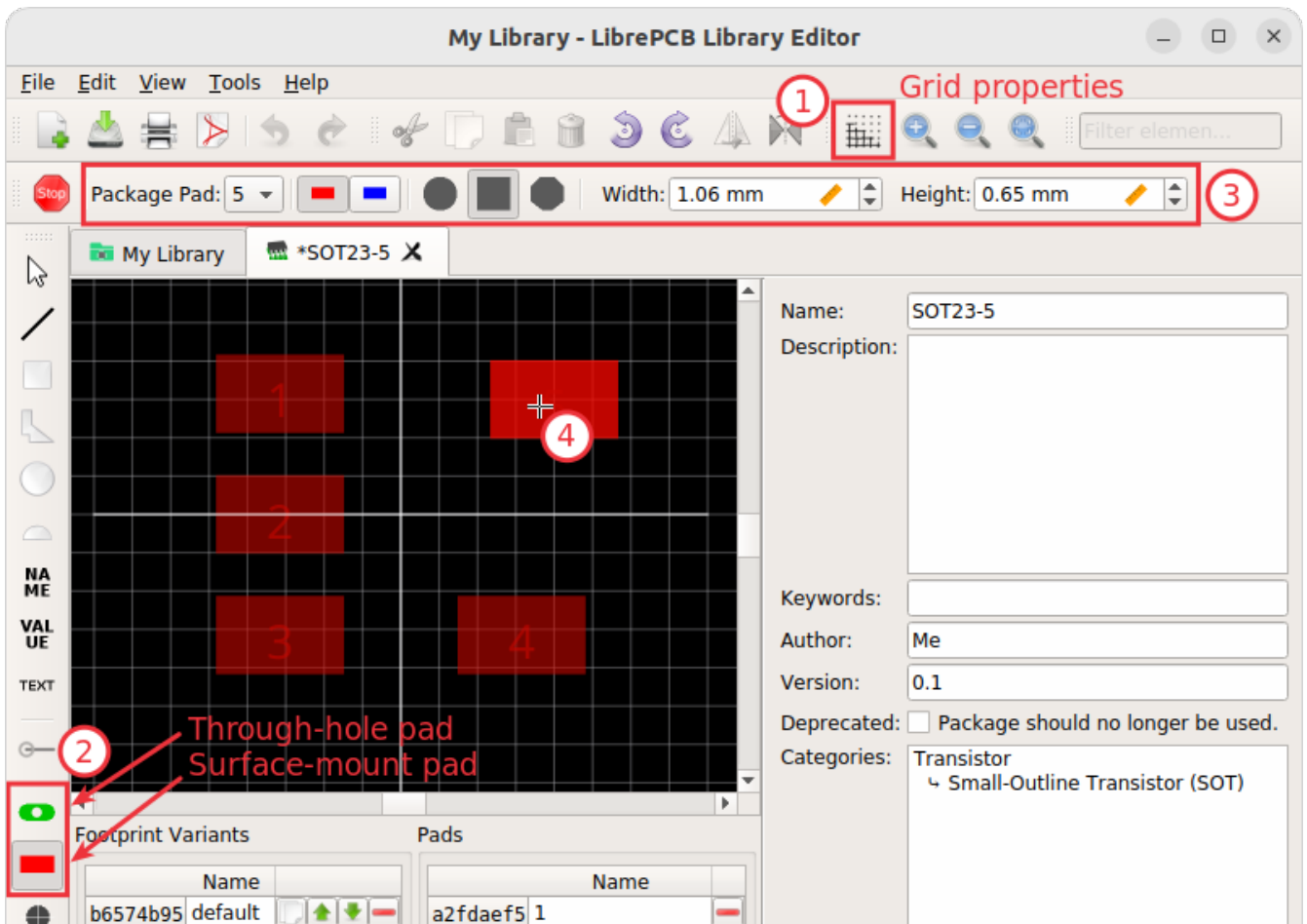

The tool only allows to place pads on the grid. To specify exact coordinates, just place the pads roughly and open **[Properties]** from the pad's context menu (right-click) afterwards to enter exact values.

Draw Polygons

Then add graphical object just as done in the symbol editor:

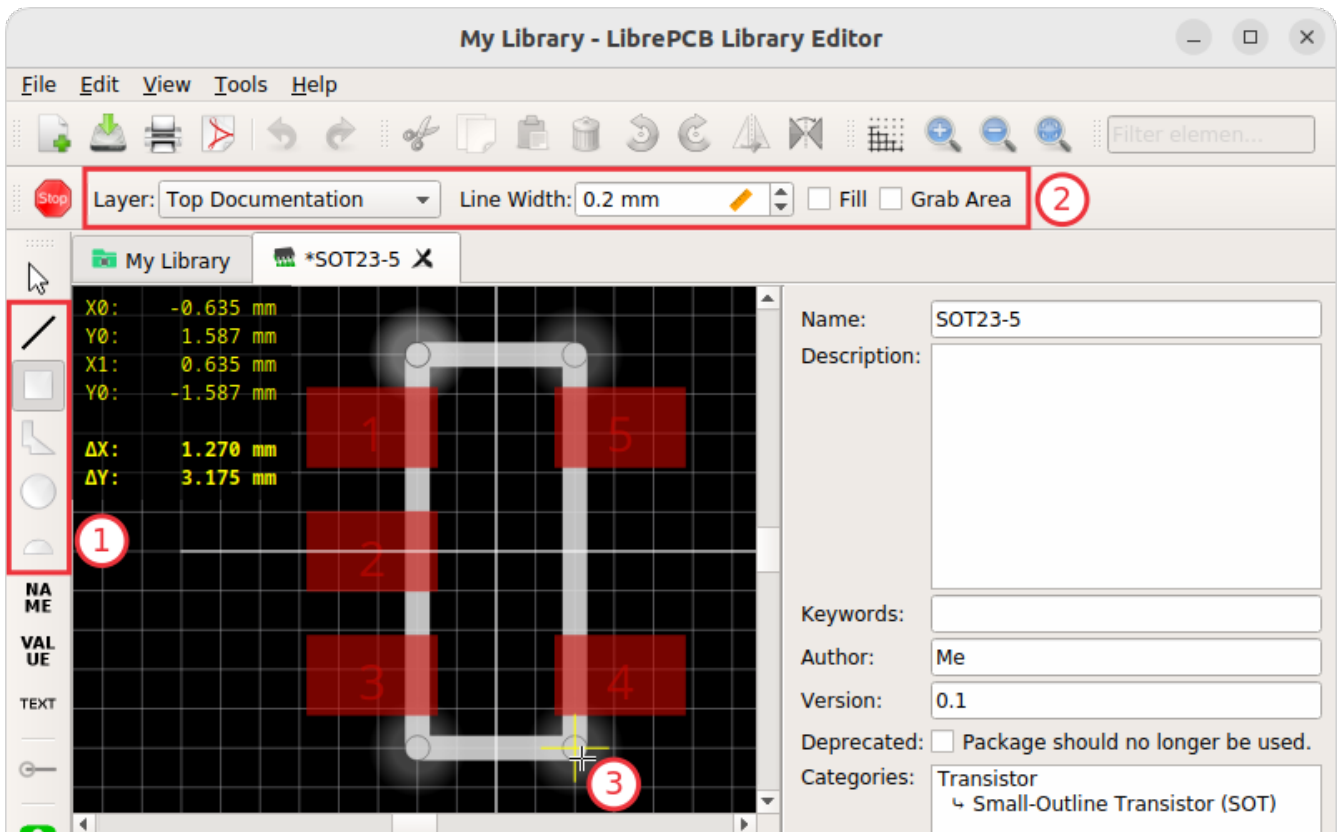

It's recommended to add at least two polygons:



- One **on the *Top Documentation* layer** to represent the body outline of the package. This layer will appear on assembly drawings, but not on the PCB silkscreen.
- One **on the *Top Legend* layer** to include a placement help which will be visible on the PCB silkscreen — **most notably pad-1 markings**.

To create highly functional, beautiful looking footprints, check out our [package conventions](#).

Add Texts

Just [like in the symbol](#), you should add `{{NAME}}` and a `{{VALUE}}` text objects:

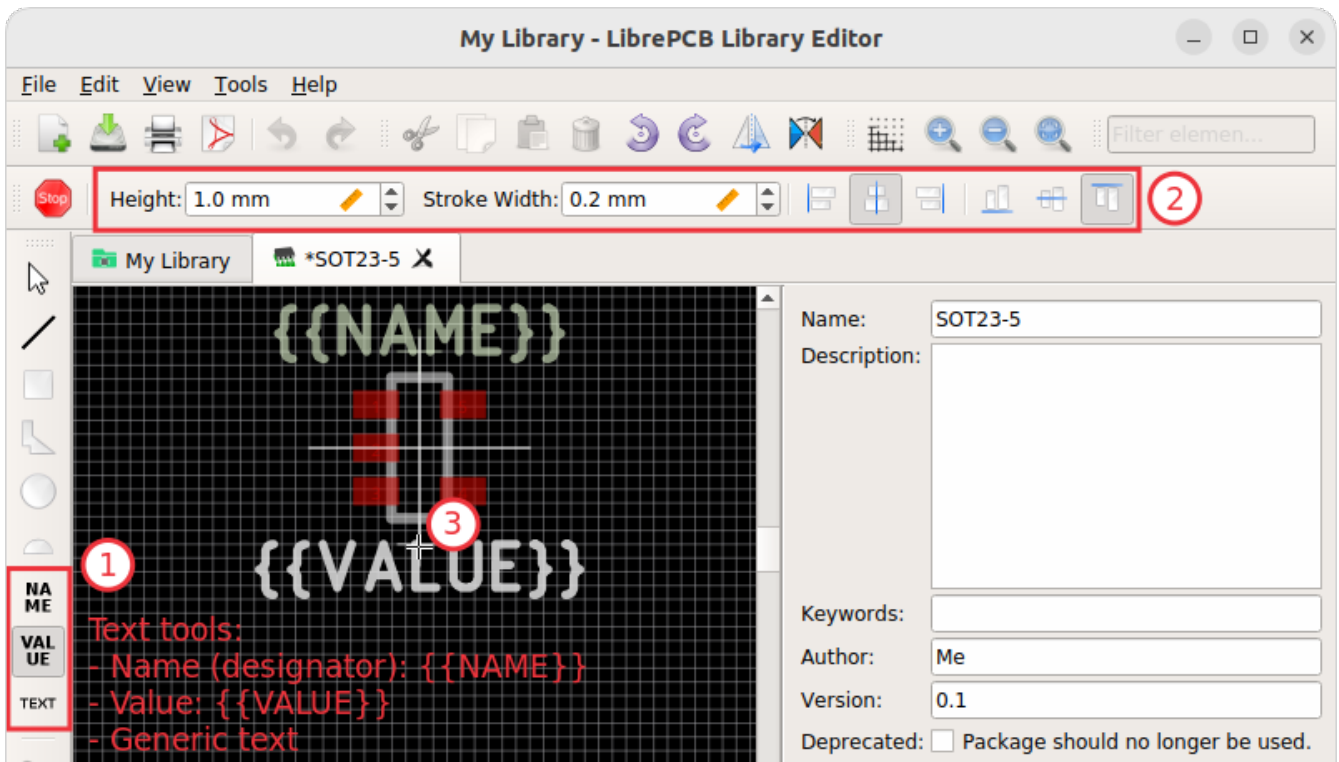

Add Non-Plated Holes

In case your package requires to drill non-plated holes into the PCB (for example to insert a screw), use the [**Add Hole**] tool and specify its diameter. However, for our SOT23-5 package we don't need a hole.

That's all you need for a simple package! Now **save the package** to ensure the background library scan picks up the new package.

Add 3D Model

If you have a STEP file of the package, you can add it as a 3D model to the package. Switch to the 3D mode with **View > Toggle 2D/3D Mode** or by pressing **Ctrl + 3**. Then click on the [+] button to import the STEP file (this may take a while):

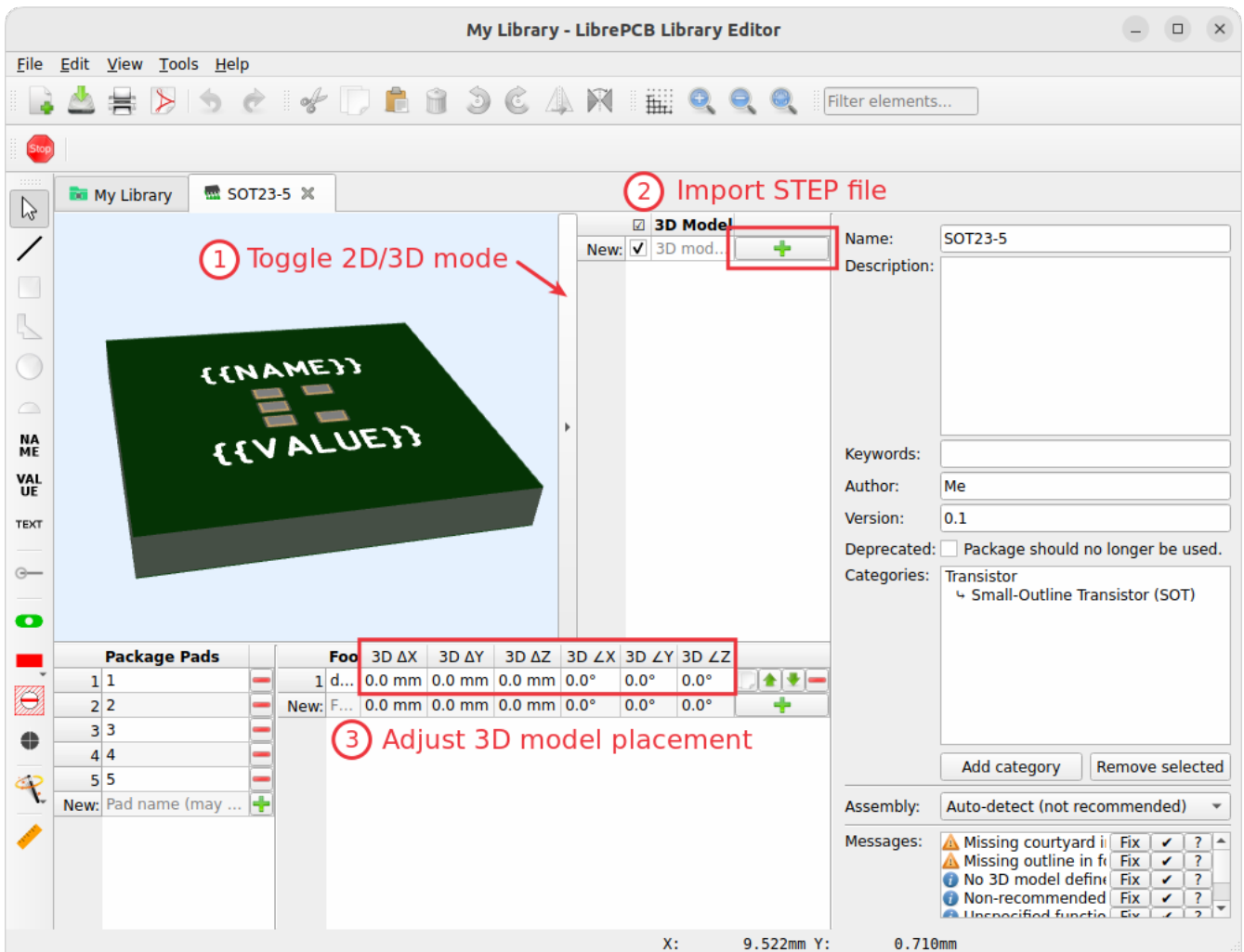

If required, the position and rotation can be adjusted in the footprint variants table.

Recommendations

For details about how packages should be designed, please take a look at our [package conventions](#). The most important rules are:

- Create generic packages, not specific ones. For example *DIP08* is *DIP08*—no matter whether it's an OpAmp, an EEPROM or a microcontroller.
- The origin (coordinate $0,0$) should be in (or near to) the center of the package body.
- Footprints must always be drawn from the top-view. When a footprint needs to appear on the bottom of a board, this can be done in the board by flipping it.
- Add **all** pads of a package, not only the one you currently need. For example if the package has a thermal pad, you should add it, even if you currently don't need it.
- Name pads according IPC-7351 (if applicable; see [package conventions](#) for more information), typically just *1*, *2*, *3* etc. Only name pads according their electrical purpose (e.g. *Anode*) if the package is very specific for a particular purpose (like an LED).
- Pad 1 should always be at the top left.
- There should be text elements for `{{NAME}}` and `{{VALUE}}`.

Device

The last library element you need to create is the device which combines the component *Single OpAmp* with the package *SOT23-5*. This is actually the only library element which is specifically for LMV321LILT — all previously created elements are generic and reusable for other OpAmps!

Again, open **New Library Element** > **Device** and specify the name and category for the new device:

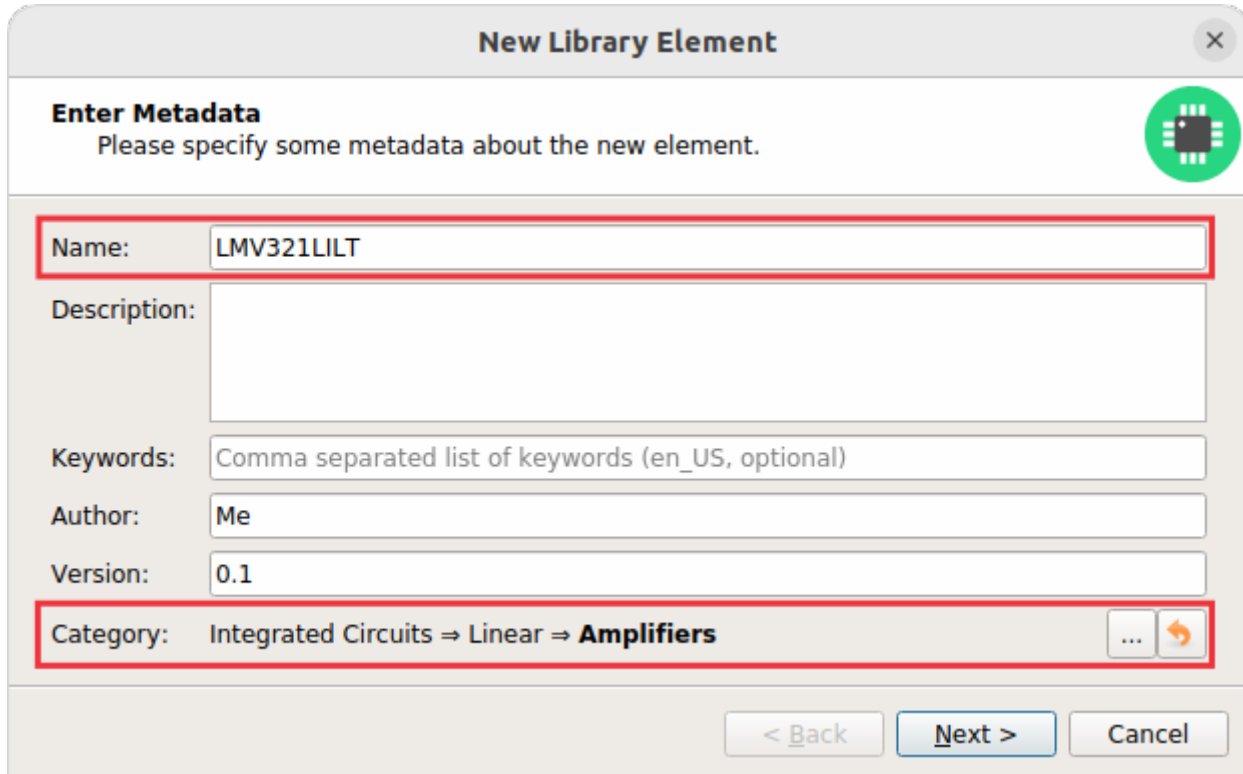

The screenshot shows the 'New Library Element' dialog box with the 'Enter Metadata' step. The dialog has a title bar with 'New Library Element' and a close button. Below the title bar is a header area with 'Enter Metadata' and a sub-header 'Please specify some metadata about the new element.' To the right of the header is a green circular icon with a black chip. The main area contains several input fields: 'Name:' with the value 'LMV321LILT', 'Description:' (empty), 'Keywords:' with the placeholder 'Comma separated list of keywords (en_US, optional)', 'Author:' with the value 'Me', and 'Version:' with the value '0.1'. The 'Category:' field is highlighted with a red box and shows a breadcrumb path: 'Integrated Circuits => Linear => Amplifiers'. To the right of the category field are three buttons: an ellipsis, a refresh icon, and a right arrow. At the bottom of the dialog are three buttons: '< Back', 'Next >', and 'Cancel'.

Choose Component & Package

After clicking [Next], you need to choose the component and package we created for this device:

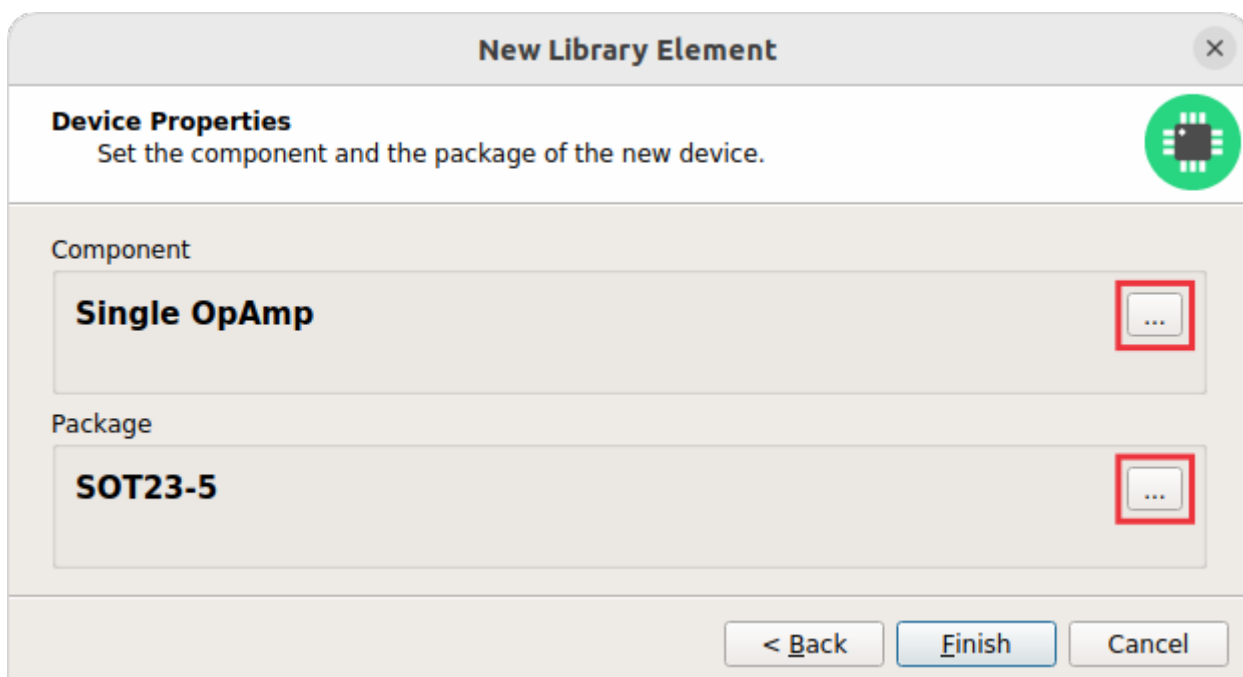

The screenshot shows the 'New Library Element' dialog box with the 'Device Properties' step. The dialog has a title bar with 'New Library Element' and a close button. Below the title bar is a header area with 'Device Properties' and a sub-header 'Set the component and the package of the new device.' To the right of the header is a green circular icon with a black chip. The main area contains two sections: 'Component' with the value 'Single OpAmp' and 'Package' with the value 'SOT23-5'. Both sections have a red box around the ellipsis button on the right. At the bottom of the dialog are three buttons: '< Back', 'Finish', and 'Cancel'.

Then click on [**Finish**].

Connect Pads To Signals

Now you have to connect the package pads to component signals according to the pinout in the datasheet of LMV321LILT:

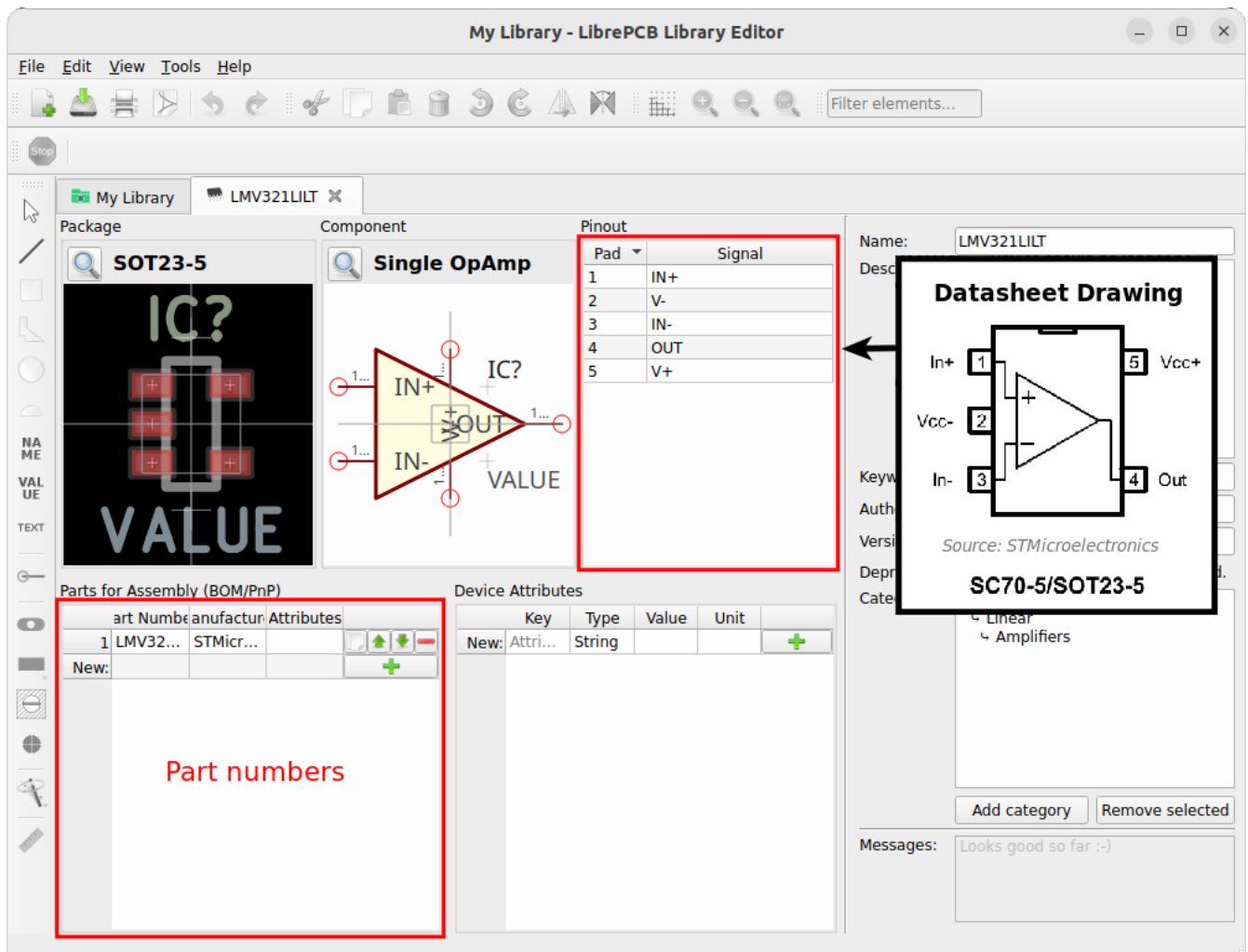

Then **save the device** to finish it and quickly wait until the background library scan completes before adding the new device to a project.

And that's it! The LMV321LILT is now ready to be added to schematics and boards. And because the categories, symbol, component and package are very generic, you created not only one single device, but the basement for many more devices in the future! For any additional single-channel OpAmp (with an already available package), you need to create only a device which is now a matter of a minute.

[1] Manufacturer part number

[2] Bill of materials

[3] Electrical rule check

User Manual

This chapter provides detailed documentation about concepts and features of LibrePCB. In contrast to the [Quickstart Tutorial](#), it does not need to be read in a particular order — just read the sections you're interested in to learn more about LibrePCB.



There are only very few things documented yet. Help us extending it [on GitHub!](#)

Layers

Layers are an integral part of every EDA software, thus it's important to know what they're intended for and how to use them. Note that all existing layers are described here, but the availability of layers within LibrePCB depends on the context. For example the layers *Top/Bottom Courtyards* are only available in the package editor, but not in the board editor since they make only sense within packages.

Schematic Layers

Sheet Frames

Intended to be used within symbols to draw schematic sheet frames (graphics and texts). Usually not used directly within schematics, but mainly in symbols. No special treatment by LibrePCB.

Documentation

General purpose layer for graphics and texts, e.g. to add some additional information to a schematic (like a formula, or a drawing of an external device). Not recommended (but possible) to be used within symbols. No special treatment by LibrePCB.

Comments

General purpose layer intended for comment annotations within schematics. Not recommended (but possible) to be used within symbols. No special treatment (yet) by LibrePCB.

Example: Text "Place C1 close to U1" next to the symbols of C1/U1

Guide

General purpose layer for graphics and texts, e.g. to draw boxes around parts of a schematic and give them a title. Not recommended (but possible) to be used within symbols. No special treatment by LibrePCB.

Outlines

Intended to draw outlines/content of symbols (e.g. a rectangle for an IC, or a thick line for a GND symbol). No special treatment by LibrePCB.

Example: [Outline](#)

Hidden Grab Areas

Used to define custom grab areas of symbols by drawing closed polygons or circles. These areas are not visible in the schematic editor, but the editor allows to grab symbols within these areas.

Only available in the symbol editor, not in the schematic editor.

Example: [Grab Area](#)

Names

Intended for the `{{NAME}}` text of symbols. Not used directly within schematics, only in symbols. No special treatment by LibrePCB.

Example: [Text Elements](#)

Values

Intended for the `{{VALUE}}` text of symbols. Not used directly within schematics, only in symbols. No special treatment by LibrePCB.

Example: [Text Elements](#)

Board Layers

Sheet Frames

Intended to be used within footprints to draw board sheet frames (graphics and texts). Usually not used directly within boards, but mainly in footprints. Ignored by the Gerber export, but usually contained when printing.

Board Outlines

Mandatory layer where a single, closed board outline polygon (or circle) must be drawn. The line represents the board edge after manufacturing. It's highly recommended to set its width to zero since it has no meaning. This layer will be exported to Gerber files and is usually contained when printing the board.

Example: [Draw Board Outline](#)



In the board editor layers dock, this layer is named *Outlines* and is coupled with the *Board Cutouts* layer.

Board Cutouts

Any non-plated board cut-outs (millings) more complex than slotted holes must be drawn on this layer as polygons or circles. The line represents the board edge after manufacturing. It's highly recommended to set its width to zero since it has no meaning. This layer will be exported to Gerber files (into the same file as the *Board Outlines* layer) and is usually contained when printing the board.

Example: [Draw Board Outline](#)



In the board editor layers dock, this layer is named *Outlines* and is coupled with the *Board Outlines* layer.

Plated Board Cutouts



Not supported yet (ignored in the Gerber export)!

Measures

General purpose layer for graphics and texts, e.g. to add manual measurements (e.g. the PCB size) to the board. Not recommended (but possible) to be used within footprints. Ignored by the Gerber export, but might be contained when printing.

Alignment

Intended to add alignment helper drawings to footprints, mainly just straight lines with zero width. For example in an edge-mounted device, the exact location of the board edge could be drawn on this layer as a help/reference for the board designer to correctly place the device in relation to the board edge. Ignored by the Gerber export, and usually not contained when printing.

Documentation

General purpose layer for graphics and texts, e.g. to add some additional information or drawings to a board. Not recommended (but possible) to be used within footprints. Ignored by the Gerber export, but might be contained when printing.

Comments

General purpose layer intended for comment annotations within boards. Not recommended (but possible) to be used within footprints. Ignored by the Gerber export, but might be contained when printing.

Guide

General purpose layer for graphics and texts, e.g. to draw boxes around parts of a board and give them a title. Not recommended (but possible) to be used within footprints. Ignored by the Gerber export, but might be contained when printing.

Top/Bottom Names

Intended for the `{{NAME}}` text of footprints. Not used directly within boards, only in footprints. Usually printed on silkscreen (by the Gerber export), depending on the board setup configuration.

Example: [Text Elements](#)

Top/Bottom Values

Intended for the `{{VALUE}}` text of footprints. Not used directly within boards, only in footprints. Might be printed on silkscreen (by the Gerber export), depending on the board setup configuration.

Example: [Text Elements](#)

Top/Bottom Legend

Intended for any drawings to appear on silkscreen, e.g. device placement/orientation lines, pin-1 dots and custom text. To be used within footprints or directly within boards. Typical line width is 0.2 mm, recommended minimum is 0.1 mm. Usually printed on silkscreen (by the Gerber export), depending on the board setup configuration.

Example: [Legend Layer](#)

Top/Bottom Documentation

Intended for drawings to represent devices in a nice way, including body outlines, leads and polarity/pin-1 markings. Basically as a 2D projection of the 3D model to somehow see the packages in 2D views, for example to export a nice looking assembly plan. Ignored by the Gerber export, but usually contained when printing.

Example: [Documentation Layer](#)

Top/Bottom Package Outlines

Intended for footprints to draw the exact mechanical outlines of the device to be assembled. To be drawn with a zero-width polygon or circle. Used by the DRC to detect and warn about overlapping devices, or devices placed within the courtyard of another device. This DRC check doesn't work if no package outline is drawn.

Top/Bottom Courtyard

Intended for footprints to draw the courtyard (clearance) of the device to be assembled, typically just the package outlines with a small offset (e.g. 0.2 mm). To be drawn with a zero-width polygon or circle. Used by the DRC to detect and warn about devices placed within the courtyard of another device. This DRC check doesn't work if no courtyard is drawn.

Top/Bottom Hidden Grab Areas

Used to define custom grab areas of footprints by drawing closed polygons or circles. These areas are not visible in the board editor, but the editor allows to grab devices within these areas. Only available in the footprint editor, not in the board editor.

Top/Bottom Stop Mask

Used to add solder resist openings, i.e. areas on the PCB where no solder resist shall be applied. So in contrast to most other layers, this layer has inverted polarity. Note that LibrePCB adds content on this layer automatically where necessary (pads, holes etc.), so manual usage of this layer is generally not needed. But it still allows to add custom solder resist openings. Any content on this layer is exported to the corresponding Gerber files.

Top/Bottom Solder Paste

Used to add stencil openings, i.e. areas on the PCB where solder paste is applied for reflow soldering of THT devices. Note that LibrePCB adds content on this layer automatically for SMT pads, so manual usage of this layer is generally not needed. But it still allows to add custom solder paste areas. Any content on this layer is exported to the corresponding Gerber files.

Top/Bottom Finish



Not supported yet (ignored in the Gerber export)!

Top/Bottom Glue



Not supported yet (ignored in the Gerber export)!

Top/Inner/Bottom Copper

Should be pretty clear ☐ Inner layers are numbered from top to bottom, i.e. *Inner Copper 1* is just below *Top Copper* and on a 6-layer PCB *Inner Copper 4* is just above *Bottom Copper*.

Custom Layers

To allow sharing symbols and footprints between users, it's crucial that the purpose of every layer is identical for each user. Therefore LibrePCB does not allow to add custom, user-defined layers.

If the built-in layers are not sufficient for you, please [let us know](#).

Licenses

When creating a new project, LibrePCB allows to specify a license for it. This chapter gives an overview about the available licenses to help you deciding which makes most sense for your project.

First of all, choosing a license is not mandatory. Especially if you don't intend to make the project public, it's totally fine to skip the license selection. However, for projects made public it's highly recommended to specify a license to let other people know what they are allowed or not allowed to do with your project. Theoretically you could write your own license text, but it's recommended to choose one of the already existing, well-known licenses.



Please always read the full, original license text instead of relying on the information on this page. First, this page presents licenses in a very simplified form without all their details. Second, this documentation is not approved by a lawyer so it may not be correct. We're not responsible for any implications caused by incomplete or wrong information on this page.

Available Licenses

The following licenses are provided by LibrePCB (depending on the installed version):

License	Permissions	Conditions	Limitations
CC0-1.0 Summary	<input type="checkbox"/> Distribution <input type="checkbox"/> Modification <input type="checkbox"/> Commercial use		<input type="checkbox"/> No liability <input type="checkbox"/> No warranty
CC-BY-4.0 Summary	<input type="checkbox"/> Distribution <input type="checkbox"/> Modification <input type="checkbox"/> Commercial use	<input type="checkbox"/> License and Copyright Notice <input type="checkbox"/> State Changes	<input type="checkbox"/> No liability <input type="checkbox"/> No warranty
CC-BY-SA-4.0 Summary	<input type="checkbox"/> Distribution <input type="checkbox"/> Modification <input type="checkbox"/> Commercial use	<input type="checkbox"/> License and Copyright Notice <input type="checkbox"/> State Changes <input type="checkbox"/> Same License	<input type="checkbox"/> No liability <input type="checkbox"/> No warranty
CC-BY-NC-4.0	<input type="checkbox"/> Distribution <input type="checkbox"/> Modification	<input type="checkbox"/> License and Copyright Notice <input type="checkbox"/> State Changes	<input type="checkbox"/> No liability <input type="checkbox"/> No warranty <input type="checkbox"/> Non-commercial only
CC-BY-NC-SA-4.0	<input type="checkbox"/> Distribution <input type="checkbox"/> Modification	<input type="checkbox"/> License and Copyright Notice <input type="checkbox"/> State Changes <input type="checkbox"/> Same License	<input type="checkbox"/> No liability <input type="checkbox"/> No warranty <input type="checkbox"/> Non-commercial only

License	Permissions	Conditions	Limitations
CC-BY-NC-ND-4.0	<input type="checkbox"/> Distribution <input type="checkbox"/> (Modification)	<input type="checkbox"/> License and Copyright Notice <input type="checkbox"/> State Changes	<input type="checkbox"/> No liability <input type="checkbox"/> No warranty <input type="checkbox"/> No derivatives <input type="checkbox"/> Non-commercial only
CC-BY-ND-4.0	<input type="checkbox"/> Distribution <input type="checkbox"/> (Modification) <input type="checkbox"/> Commercial use	<input type="checkbox"/> License and Copyright Notice <input type="checkbox"/> State Changes	<input type="checkbox"/> No liability <input type="checkbox"/> No warranty <input type="checkbox"/> No derivatives
TAPR-OHL-1.0	<input type="checkbox"/> Distribution <input type="checkbox"/> Modification <input type="checkbox"/> Commercial use	<input type="checkbox"/> License and Copyright Notice <input type="checkbox"/> State Changes <input type="checkbox"/> Same License <input type="checkbox"/> Notify upstream developers	<input type="checkbox"/> No liability <input type="checkbox"/> No warranty
CERN-OHL-P-2.0 Summary FAQ	<input type="checkbox"/> Distribution <input type="checkbox"/> Modification <input type="checkbox"/> Commercial use	<input type="checkbox"/> License and Copyright Notice <input type="checkbox"/> State Changes	<input type="checkbox"/> No liability <input type="checkbox"/> No warranty
CERN-OHL-W-2.0 Summary FAQ	<input type="checkbox"/> Distribution <input type="checkbox"/> Modification <input type="checkbox"/> Commercial use	<input type="checkbox"/> License and Copyright Notice <input type="checkbox"/> State Changes <input type="checkbox"/> Same License (relaxed) <input type="checkbox"/> Disclose source	<input type="checkbox"/> No liability <input type="checkbox"/> No warranty
CERN-OHL-S-2.0 Summary FAQ	<input type="checkbox"/> Distribution <input type="checkbox"/> Modification <input type="checkbox"/> Commercial use	<input type="checkbox"/> License and Copyright Notice <input type="checkbox"/> State Changes <input type="checkbox"/> Same License (strong) <input type="checkbox"/> Disclose source	<input type="checkbox"/> No liability <input type="checkbox"/> No warranty

License and Copyright Notice

A copy of the license and copyright notice must be included with the licensed material.

State Changes

Modifications made to the licensed material must be documented.

Same License

If you remix, transform, or build upon the material, you must distribute your contributions under the same license as the original.

Other Licenses

If you like to use a license not available in LibrePCB, or if you're not sure yet and want to decide later, just skip the license selection when creating the project. Then add it manually afterwards as follows:

1. Close the project in LibrePCB.
2. In the root directory of the project, add a file named `LICENSE.txt` containing the license terms.
3. Open `README.md` in a text editor and replace this line:

No license set.

by this one:

See [[LICENSE.txt](#)]([LICENSE.txt](#)).

Or if you want to switch to a different license after you created a new project, just replace the file `LICENSE.txt` manually. LibrePCB itself does not provide a tool to change the license of an existing project.

Additional Actions

Note that some licenses may require to perform additional actions to correctly apply those licenses to a project. This applies mainly to the OHL licenses, but to be sure please check the license texts.



Please help us documenting the additional actions [on GitHub!](#)

Recommendation

Of course choosing a license is a personal decision and any recommendation from our side will be subjective. But generally, if you simply don't care what people will do with your project, or you want to give them maximum freedom (without any liability or warranty from your side), we think **CC0-1.0** is a great choice as this will allow *everyone* to use your project for *any* purpose. If you want to be quite restrictive and don't want your project to be used for closed-source products, **CERN-OHL-S-2.0** shouldn't be a bad choice.

License of Libraries

Not only projects, but also libraries can be released under a certain license. However, we think public libraries should be released exclusively under the **CC0-1.0** license. Any other license would make it too complicated for other people to create projects using these libraries, fulfilling all license terms of any used library.

Thus when creating a new library, CC0-1.0 is the only available option and all official libraries are published under this license so you can do with these libraries whatever you want, whether for commercial or non-commercial use.

Project Editor

Assembly Data

This chapter explains how to specify assembly data like MPNs^[1] in your project to get an accurate BOM^[2] ready to order the correct parts. LibrePCB supports many different use-cases which will be explained below.



Assembly data is a rather advanced topic, and often not that relevant for simple

hobby projects which are assembled by hand. So for your first steps with LibrePCB, you could simply ignore this whole topic. LibrePCB will let you generate a BOM for your project anyway, it might just be less accurate (e.g. missing exact MPNs).

Assembly Variants

First of all, you should understand the concept of assembly variants because the assembly data of each part is related to an assembly variant.

Basically an assembly variant simply represents a variation of the BOM. For each assembly variant you'll get a separate BOM which may differ in which parts are contained, or what MPNs are specified for the parts. So if your project contains 5 assembly variants, the BOM export will create 5 BOM files.

Every project requires to contain at least one assembly variant. LibrePCB therefore automatically adds a default variant called *Std* when you create a new project. In many cases, this is sufficient and you don't need to care about assembly variants at all.

However, there are use-cases where you want to generate different BOMs for a single PCB project. Usually this is desired if multiple different products are created from the same PCB, differing only on the assembled parts. For example the same PCB could be assembled with either an RS485 interface, or with an Ethernet interface (or both). Or a voltage regulator module can either output 3.3V or 5V, depending on the value of an assembled resistor.

To define the assembly variants, open **Project > Project Setup** or press **F6** and navigate to the **Assembly Variants** tab:

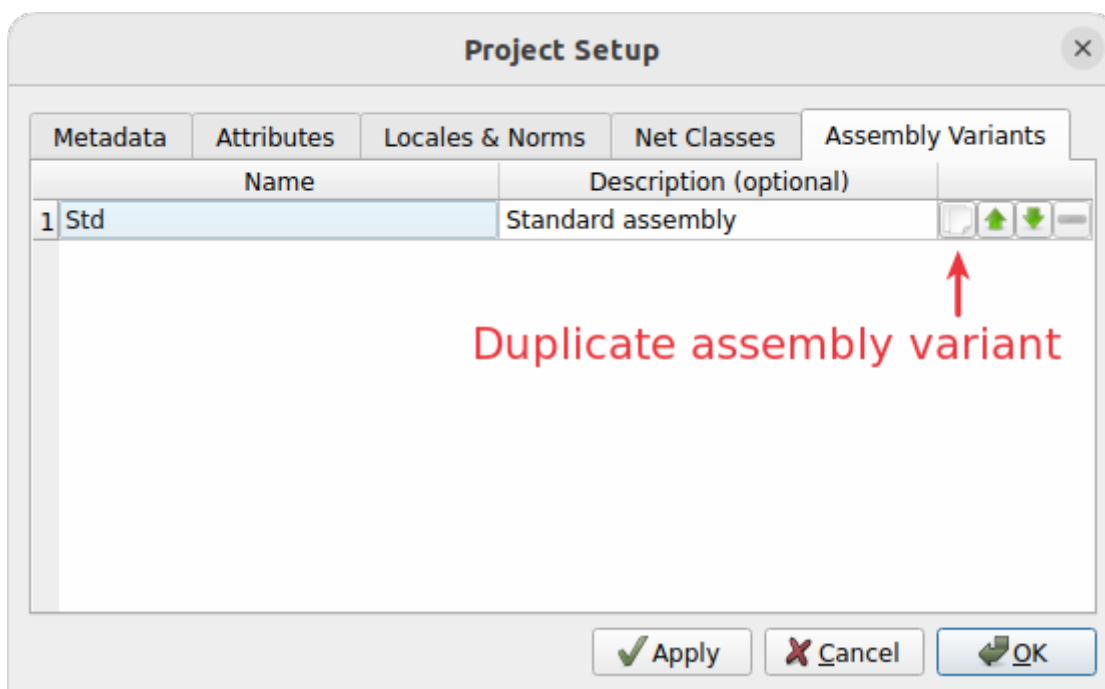

A new assembly variant can only be added by duplicating an existing one. The new variant will then initially contain exactly the same parts as the existing one.



It's highly recommended to keep the variant name as short as possible (e.g.

just 5V instead of *OutputVoltage5V*) because it will be part of the file name of the exported BOMs. It must therefore also not contain any special characters. A more descriptive name may be specified in the *Description* field.

If one of the variants is considered as the default or most used variant, it's recommended to move it to the top of the list. Some features in LibrePCB will respect only the first assembly variant, no matter how many are defined.

Component Assembly Data

The assembly variants explained above are defined at project scope, i.e. they are valid for a whole project. This section now describes what assembly data is defined on *component scope*.

Add Component By MPN

Often, assembly data for a component consists of a manufacturer name and an MPN (the part number). Those two values are sufficient to know which part needs to be ordered from your supplier.

The easiest way to add this data to a component is at the time when you add a new component to the schematic. Maybe you remember this screenshot from the [Quickstart Tutorial](#):

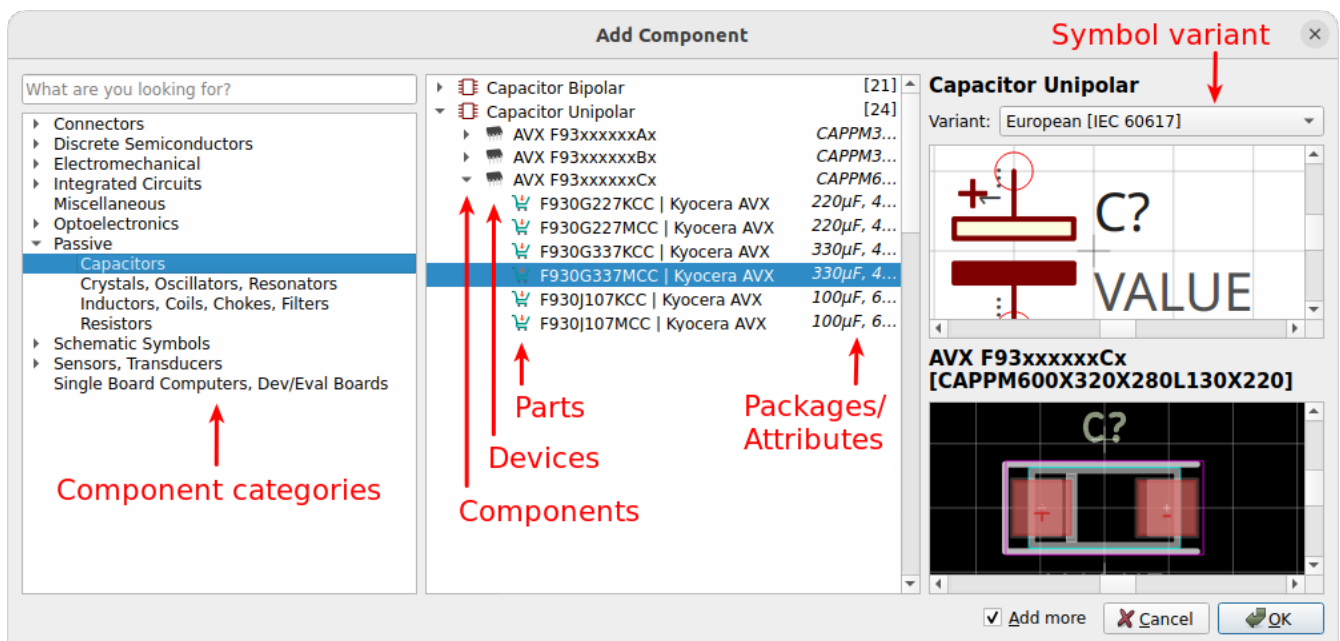

You can add either a *component*, a *device* or a *part* to the schematic. Components and devices however do not contain any assembly data. But if you add a part, the component in the schematic will automatically contain the MPN and (usually) the manufacturer as assembly data. So in that case, no manual action is needed anymore.

Assembly Data Editor

No matter if you added components by MPN to the schematic or not, the assembly data of a component can always be manually edited in its properties dialog. This is also required for more complex scenarios, e.g. if you like to exclude a component from a particular assembly variant or if you like to specify second source parts.

Click on **Properties** from the components context menu or select the component in the schematic and press **E**:

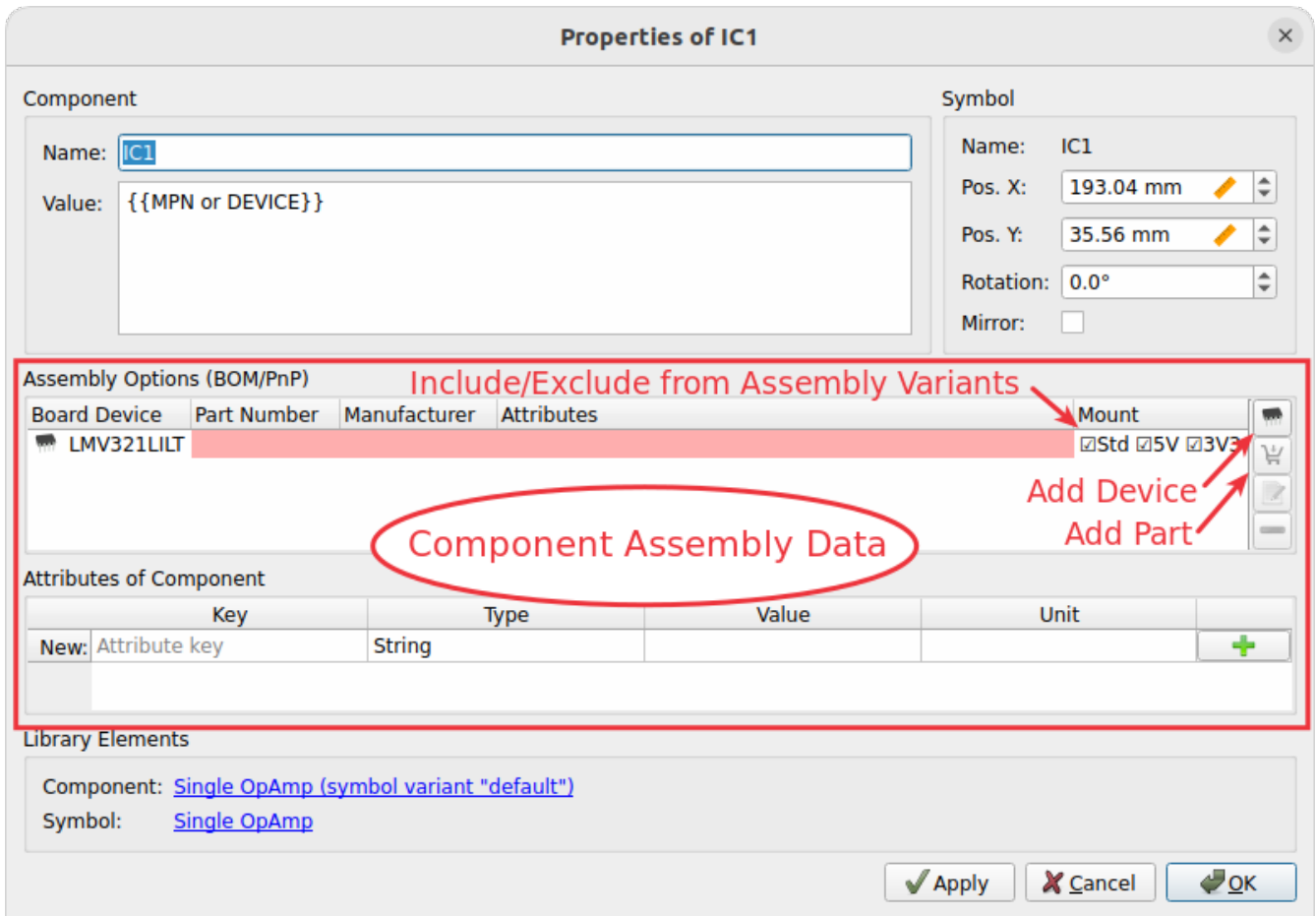

Each row in this table represents one assembly data set (or a *part*). Note that each part is valid only for a particular device—for example an OpAmp might be provided in a SOT23-5 package by one device, and in a DIP8 package by another device. So it's clear their order information will be different. Thus the first column specifies for which device a part is valid for.

In the last column, you can specify for which assembly variants a part is valid for, i.e. in which variants the part shall be assembled.

The three columns in the middle contain the actual assembly data which is accessed by the BOM export. This might be an MPN and manufacturer name, but it might also be just a single attribute like `CAPACITANCE=100nF`. Empty fields do not mean the part will be excluded from the BOM—the corresponding BOM fields will just be empty as well.



Unfortunately the UI is a bit confusing at the moment, we'll try to improve it in upcoming releases. The most important thing to know is that **the attributes editor at the bottom is related to the selected row in the assembly options table**. So to specify an attribute for a particular assembly option, select the corresponding row and add the attribute to the table afterwards.



If no assembly option is selected, the attributes table displays the attributes set **directly on the component** (i.e. attributes not depending on assembly variants).

No worries if you don't fully understand the concept yet. The sections below will show you concrete

examples for each of the possible use-cases.

Example: Specify MPN

As mentioned above, each part could either be represented by an MPN plus manufacturer name, or just as simple attributes. If you want to have an MPN contained in the BOM, click on the **[Add Part By MPN]** button and choose a part. If the desired part doesn't exist in the library, just choose a device instead and type in the MPN and manufacturer manually. The result should then look like this:

Board Device	Part Number	Manufacturer	Attributes	Mount	
LMV321LILT	LMV321LILT	STMicroelectronics		<input checked="" type="checkbox"/> Std <input checked="" type="checkbox"/> 5V <input checked="" type="checkbox"/> 3V3	 



Add part by MPN 



- A row in the table needs to be selected to enable the mentioned button (not shown in the screenshot for readability reasons).
- If there's no row in the table at all yet, use the upper button **[Add Device]** instead. It works the same way, but adds a new assembly option (i.e. a row) instead of modifying an existing one.

Example: Specify Attributes

If you don't care about an exact MPN but just want to specify some attributes (like the capacitance of a capacitor), select the corresponding row and add the attributes to the attributes table. The result should look like that:

Board Device	Part Number	Manufacturer	Attributes	Mount	
Capacitor 2012 (0805)			100nF	<input checked="" type="checkbox"/> Std <input checked="" type="checkbox"/> 5V <input checked="" type="checkbox"/> 3V3	 

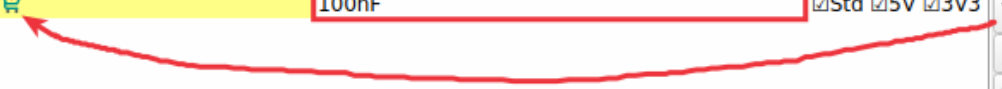



- If there's no shopping cart symbol in the desired row, you first need to add initial part information with the **[Add Part By MPN]** button as explained in the previous section. Just select a device instead of a part.
- If there's no row in the table at all yet, use the upper button **[Add Device]** first and select the desired device. Afterwards proceed as explained above.

Unfortunately this procedure is a bit cumbersome, we'll try to improve it in upcoming releases.



Note that these attributes are not automatically included in the BOM. Usually, only the `{{VALUE}}` of components is included, so it's recommended to include any relevant attributes in the component's value.

For example if you want to have the attributes `{{CAPACITANCE}}` and `{{VOLTAGE}}` of a (capacitor) component included in the BOM, set the component value to this:

```

{{CAPACITANCE}}
{{VOLTAGE}}

```

Example: Do Not Mount

A typical use-case of assembly variants is to simply exclude some components from particular assembly variants. This is done by unchecking the corresponding variants in the last column:

Board Device	Part Number	Manufacturer	Attributes	Mount
LMV321LILT	LMV321LILT	STMicroelectronics		<input checked="" type="checkbox"/> Std <input checked="" type="checkbox"/> 5V <input type="checkbox"/> 3V3

↑
Excluded from assembly variant "3V3"

So this component won't be contained in the BOM for 3V3, but it will be contained in the BOM for the other two assembly variants.



If your project contains only one assembly variant, the last column won't display its name. In that case there will be just a plain checkbox, but this procedure works exactly the same way.

Example: Alternative Parts (2nd Source)

Another possible use-case is to specify alternative part numbers (or attributes) for a component, to make the assembly house know which other parts they can choose if the primary part is out of stock.

This is done by selecting the corresponding assembly option row and clicking on the **[Add Part By MPN]** button multiple times, once for each alternative part. The first one is automatically considered as the *primary* part, while any further parts are *alternative* parts. The result should look like that:

Board Device	Part Number	Manufacturer	Attributes	Mount
LMV321LILT	LMV321LILT	STMicroelectronics		<input checked="" type="checkbox"/> Std <input checked="" type="checkbox"/> 5V <input checked="" type="checkbox"/> 3V3
↳ Alternative 1:	MCP6001RT-I/OT	Microchip Technology		
↳ Alternative 2:	OPA338NA/250	Texas Instruments		

Add part by MPN →

This will cause the BOM to include three additional columns (those ending with [#] where # is an incrementing number) for each alternative part (common columns omitted and text abbreviated for readability):





Value	MPN	Manufac turer	Value[2]	MPN[2]	Manufac turer[2]	Value[3]	MPN[3]	Manufac turer[3]
	LMV321	ST		MCP6001	Microchi p		OPA338	TI

Instead of specifying alternative parts by MPN, you could also specify alternative parts by attributes exactly the same way — just specify attributes instead of MPNs ☐





Example: Different Assembly Variants

Last but not least, it is also possible to include a component in multiple assembly variants, but using different parts. This can be done by adding multiple rows with the **[Add Device]** button and selecting the checkboxes accordingly.

For example to assemble the part *LMV321LILT* in the *3V3* assembly variant, but *OPA338NA/250* in the other two assembly variants, it would look like that:

Board Device	Part Number	Manufacturer	Attributes	Mount
 LMV321LILT	 LMV321LILT	STMicroelectronics	→	<input type="checkbox"/> Std <input type="checkbox"/> 5V <input checked="" type="checkbox"/> 3V3
 LMV321LILT	 OPA338NA/250	Texas Instruments	→	<input checked="" type="checkbox"/> Std <input checked="" type="checkbox"/> 5V <input type="checkbox"/> 3V3

Once again, exactly the same procedure works for specifying different attributes instead of MPNs:

Board Device	Part Number	Manufacturer	Attributes	Mount
 Capacitor 2012 (0805)			100nF →	<input type="checkbox"/> Std <input type="checkbox"/> 5V <input checked="" type="checkbox"/> 3V3
 Capacitor 2012 (0805)			220nF →	<input checked="" type="checkbox"/> Std <input checked="" type="checkbox"/> 5V <input type="checkbox"/> 3V3

In this example, the BOM for the *3V3* assembly variant specifies 100nF for the capacitor, while the BOMs for the other variants specify 220nF.

Usage Of Assembly Data

As explained earlier, the assembly data is mainly used for the BOM export. However, there are also some other things depending on assembly data.

Schematics

In schematics, typically you see the attributes and/or MPNs next to each component (usually in the `{{VALUE}}` label). But as you should now understand, this data could depend on the assembly variant or there could also be multiple MPNs added to a component. So the question arises, which of them is displayed in schematics?

The rules for substituting the placeholder `{{VALUE}}` in schematics are as follows:

1. If there exists at least one board, and the first board (which is considered as the *primary* board) contains a device for the component in question, and there is at least one part assigned to that device, any attributes from that first part are displayed in schematics.
2. If there is no such board, device or part, but the component has at least one part assigned, any attributes from that first part are displayed instead.
3. If there is no part assigned to the component at all, only the direct component attributes are taken into account (which are not depending on the assembly variant, and usually don't contain an MPN). Note that component attributes are always taken into account anyway in case a part doesn't specify a particular attribute (fallback mechanism).

3D Board Viewer

The 3D board viewer displays only devices which are contained in the first defined assembly variant (i.e. the *default* variant). So if a device is excluded from that assembly variant, its 3D model won't show up in the 3D view.

BOM Output Job

The biggest effect of assembly data is for sure the BOM export. As explained above, for each assembly variant a separate BOM file will be created. Strictly speaking, this is not always true since it is configurable — but at least it's the default behavior.

Let's take a look at the options of the BOM output job:

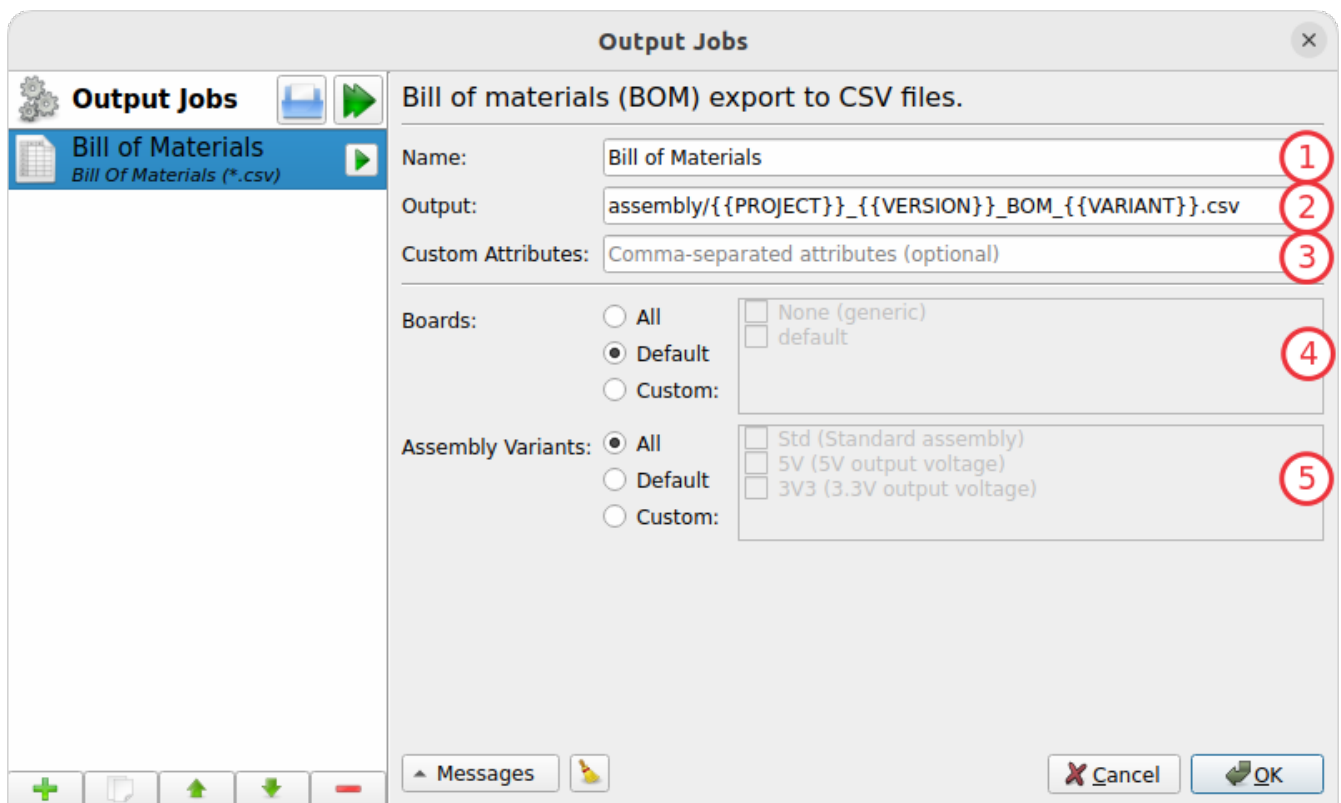

1) Name

Name of the output job as shown in the list on the left (no impact on the exported files).

2) Output

File path of the BOM files to generate. Since multiple files might be generated, placeholders are required to avoid conflicting file paths. The most important placeholder here is `{{VARIANT}}` which will be substituted by the name of the assembly variant (e.g. *Std*).

3) Custom Attributes

Comma-separated list of additional columns to be included in the BOM CSV files. For example the value `SUPPLIER,DATASHEET` adds two more columns to the CSV with the component attributes `SUPPLIER` and `DATASHEET`. Usually this field can just be left empty.

4) Boards

Selection of boards to export BOMs for. If your project contains multiple boards and you want to

get a BOM for each of them (since they usually differ!), you may choose *All* or *Custom* here.

Attention: If multiple boards are selected, you have to add the placeholder `{{BOARD}}` (or any other board-specific attribute) to the output file path to avoid generating conflicting files!

5) Assembly Variants

This option does exactly the same as the *Boards* option, just for assembly variants. Here you'll see that *All* is selected by default to get a separate BOM file for each assembly variant. And that's why the `{{VARIANT}}` placeholder is contained in the output file path by default.

For the latter two options, the value *Default* just means that the *first* object is used, i.e. the first board or the first assembly variant.

Note that **every generated BOM will contain only those components which are contained in the corresponding assembly variant**. Components excluded from a particular assembly variant won't appear in the BOM at all (no "do-not-mount" mark or something like that).



Similarly, only components actually added to the selected board will be contained in the BOM. Even if a component is contained in an assembly variant, but not added to the board selected for the export, it won't be contained in the BOM.

If a component specifies multiple parts (e.g. for second source reasons), the BOM will contain additional columns to include all those parts. So the number of columns depends on the maximum number of parts added to components. Of course only those parts valid for the selected board will be contained in the BOM.

Other Output Jobs

Although the BOM export is the primary use for assembly data, the same concept also applies to these output jobs:

- Pick&Place CSV / Gerber X3
- Board STEP Model

Software Architecture

For the nerds among us, this diagram about the underlying software architecture might help to understand this feature:

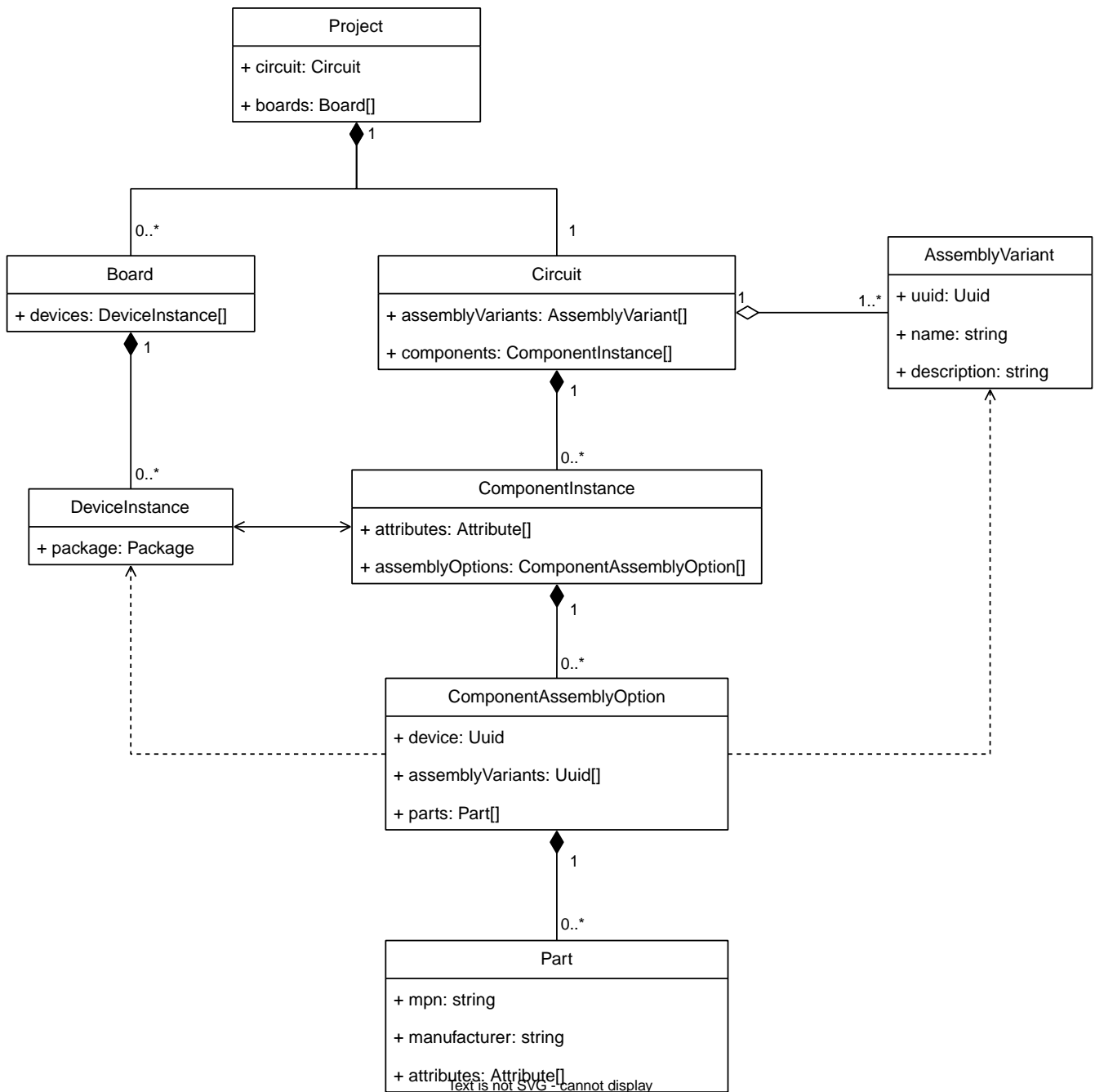

Output Jobs

At the end of every PCB project, we need to generate various production data files, e.g. for PCB manufacturing, PCB assembly, or simply for documentation purposes. LibrePCB provides a unified interface to generate any kind of production data for a project. It is called *Output Jobs*.

From either the schematic- or board editor, open the *Output Jobs* dialog with the menu item **File > Output Jobs...** or by pressing **F11**:

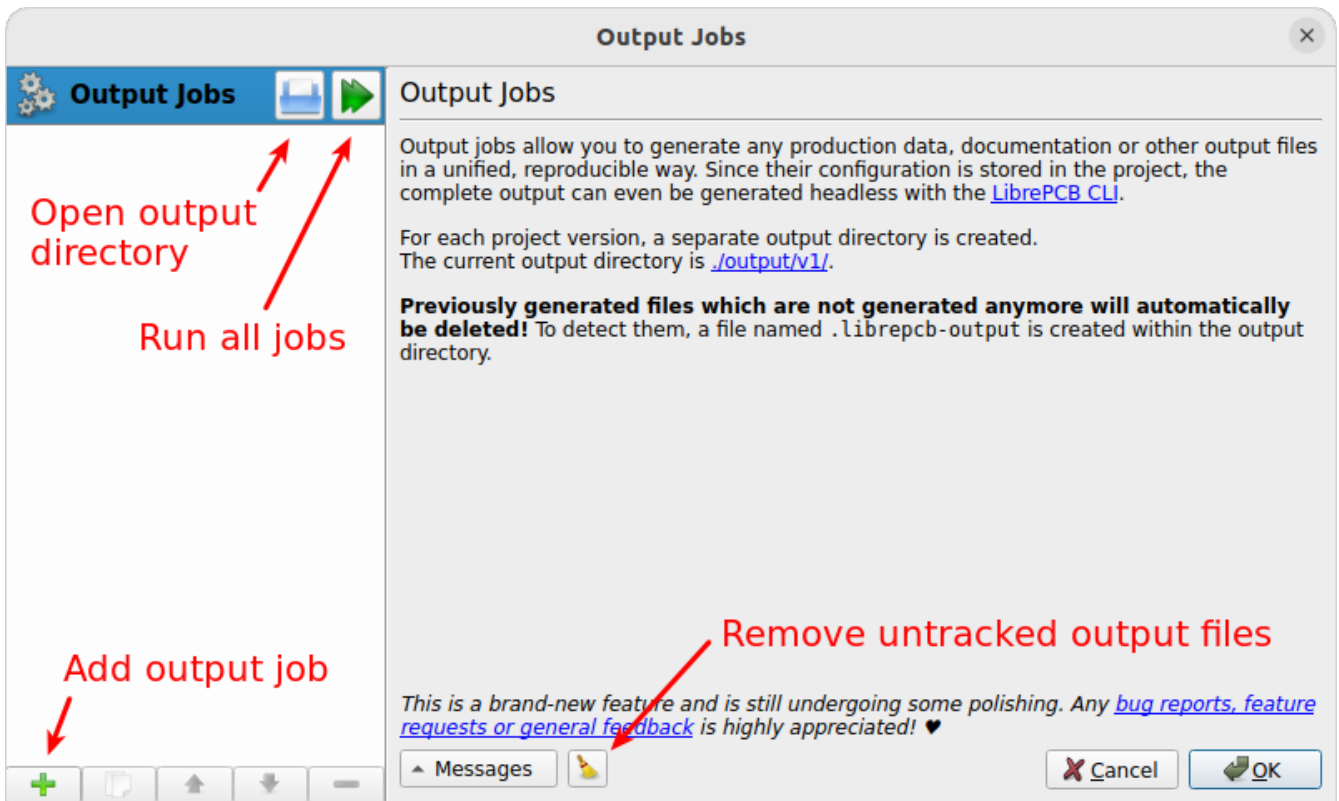

Output Directory

Any output files are always generated into the project directory `output/<VERSION>/` where `<VERSION>` represents the project's version number as specified in the project setup dialog (F6). So for the default version number `v1`, the output data goes to `output/v1/` within the project directory.



Since existing output files are overwritten without prompt when running jobs, always make sure the version number has the desired value (e.g. bump it after releasing a PCB version).

Note that LibrePCB automatically creates a file named `.librepcb-output` within this output directory. It is used internally to detect untracked output files (see details below).

Add Jobs

The list of output jobs is initially empty for every new project. So for any output data you like to generate, you need to add a corresponding job with the plus button at the bottom left. This will add a new job to the list on the left side of the dialog. Select the new job to modify its properties.

This way you can add as many jobs as you need, even multiple jobs of the same type are allowed (e.g. if different settings are needed). The available job types and their configuration options are listed below.

Run Jobs

Once you added all desired jobs, you can run them either individually or all at once with the corresponding buttons in the job list. Note that every run overwrites the output files of previous runs. In addition, a run also removes previously generated files of the same job, for example after modifying the output file path configuration. This ensures that no outdated files are left over in the

output directory.

Untracked Output Files

After running any output job, LibrePCB automatically scans the output directory for any untracked files, i.e. files not generated by any output job. For example when deleting an output job, its previously generated output files are still left over in the output directory. As this might not be intended, LibrePCB reports them in the output messages and provides a button to delete them. It is your choice to either keep or delete these files.

Common Configuration Options

Although the configuration options differ from job to job, there are some options available in several jobs so these are documented here:

Name

Just a user-defined, unique name to identify each job in the list of all jobs.

Output

File path of the file(s) to generate, relative to the [Output Directory](#). May use placeholders like `{{PROJECT}}` or `{{VERSION}}`. For example the output path `{{PROJECT}}_{{VERSION}}_BOM.csv` might result in the full output file path `output/v1/MyProject_v1_BOM.csv` relative to the project's root directory.

Boards

Selection of boards to run the job for. For example if a project contains multiple boards and you want to generate Gerber files for each of them, this option allows to do that with a single output job instead of creating separate output jobs for each board. The available values are:

- **Default:** Run the job only for the default board (which is always the *first* board in a project). So the job is run exactly once, except if the project contains no board at all; then the job is not run.
- **All:** Run the job for each existing board. If no board exists, the job is not run.
- **Custom:** Manually select the boards the job shall run for (0..n). Some jobs also provide the special value "None" which means a job is run outside the context of a board.



If multiple boards are selected, you have to add the placeholder `{{BOARD}}` (or any other board-specific attribute) to the output file path to avoid generating conflicting files!

Assembly Variants

Similar to the *Boards* option, this option allows to specify the assembly variants a job shall run for. For example if a project contains multiple assembly variants and you want to generate a separate BOM for each of them, this option allows to do that with a single output job instead of creating separate output jobs for each assembly variant. The available values are:

- **Default:** Run the job only for the default assembly variant (which is always the *first* one). So the job is run exactly once.

- **All:** Run the job for each existing assembly variant.
- **Custom:** Manually select the assembly variants the job shall run for (0..n).



If multiple assembly variants are selected, you have to add the placeholder `{{VARIANT}}` to the output file path to avoid generating conflicting files!

Example 1. Boards & Assembly Variants

To help understanding the *Boards* and *Assembly Variants* options, consider a project with the boards "Board1" and "Board2", and the assembly variants "AV1" and "AV2". If you set both configuration options to "All", a job is run for each combination of them, i.e. four times:

- Run 1: `{{BOARD}}=Board1, {{VARIANT}}=AV1`
- Run 2: `{{BOARD}}=Board1, {{VARIANT}}=AV2`
- Run 3: `{{BOARD}}=Board2, {{VARIANT}}=AV1`
- Run 4: `{{BOARD}}=Board2, {{VARIANT}}=AV2`

Job Types

This section describes all the available job types and their configuration options.

PDF/Image

Generates a PDF or image(s) containing either the schematics, the board(s) or both. For convenience, there are two built-in presets to quickly generate frequently needed documents:

- **Schematic PDF/Image:** Adds a job to generate a PDF with the schematics.
- **Board Assembly PDF/Image:** Adds a job to generate a PDF with top/bottom assembly plans for the board(s).

Both presets add the same type of output job, just with different initial configuration options.

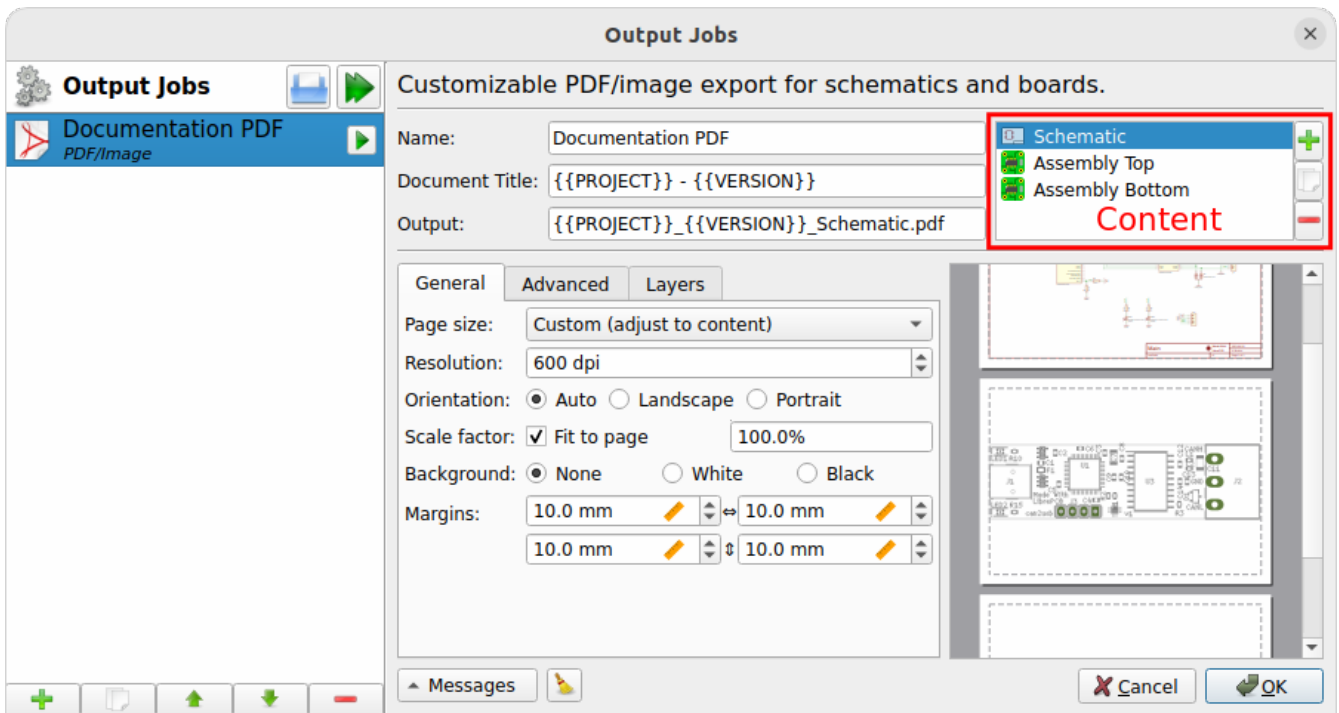

Name

See [Common Configuration Options](#).

Document Title

Title of the generated document, to be set in the metadata of the output file. This option only has an effect if the output file type is either PDF or SVG. Placeholders like `{{PROJECT}}` may be used in the value.

Output

See [Common Configuration Options](#). The specified file extension determines what output file format is used. The extension `.pdf` generates a single PDF containing all pages. The extension `.svg` generates a separate SVG for each page. Pixmap extensions like `.png` generate a separate image file for each page. Note that the supported pixmap extensions depend on the platform, but `.png` should always be available.



If multiple image files are generated, a page number is automatically appended to the file name, for example the output path `image.png` may generate the files `image1.png` and `image2.png`.

Content (list view on the right side)

The actual content of the output document is specified in the list view on the right side. A content item could either be the schematic or the board, while for the board there exist two different presets *Board Image* and *Assembly Top/Bottom* for convenience. The schematic type adds 0..n pages to the output (depending on how many sheets your project has), while a board type adds one page per board to the output document. So with this output job you can freely choose whether the output document represents a schematic, or a board, or even contains both. The pages in the output document are added in the same order as the specified content items.

General/Advanced

These options affect the layout of the output document and should be mostly self-explaining.

Note that these options refer to the currently selected content item (the list at the top right), so they are independent for each content item.

Layers

Selection of layers to be included in the output document, and their color. The color of each layer can be changed by double-clicking on a layer list item. The colors are not taken from your workspace settings to make this output job independent of user settings. Note that these layer settings refer to the currently selected content item (the list at the top right), so they are independent for each content item.

Gerber/Excellon

Generates RS-274X (Gerber X2) and IPC-NC-349/XNC (Excellon) files for PCB production. For convenience, there are two built-in presets available:

- **Gerber/Excellon:** Uses default options with **.gbr** file extension according to recommendation by the Gerber standard.
- **Gerber/Excellon (Protel style):** Configures Protel file extensions and sets some options for compatibility with cheap PCB manufacturers.

Both presets add the same type of output job, just with different initial configuration options. Please check the documentation of your desired PCB manufacturer which options are supported. If you intend to order the PCB through [LibrePCB Fab](#), you don't need to add a Gerber/Excellon output job at all.

The screenshot shows the 'Output Jobs' dialog box with the 'Gerber/Excellon' job selected. The dialog title is 'Output Jobs'. The main content area is titled 'Gerber (RS-274X) / Excellon (XNC) PCB production data export for boards.' and includes a note: 'Note that it's highly recommended to review the generated files before ordering PCBs. This could be done with the free application [gerbv](#) or the [official reference viewer from Ucamco](#).' Below this, it says 'As a simpler and faster alternative, you could use the [Order PCB](#) feature instead.'

The configuration fields are as follows:

- Name: Gerber/Excellon
- Base Path: gerber/{{PROJECT}}_{{VERSION}}
- Outlines: _OUTLINES.gbr
- Inner Copper: PPER-IN{{CU_LAYER}}.gbr
- Top Copper: _COPPER-TOP.gbr
- Bottom Copper: _COPPER-BOTTOM.gbr
- Top Stopmask: _SOLDERMASK-TOP.gbr
- Bottom Stopmask: _SOLDERMASK-BOTTOM.gbr
- Top Silkscreen: _SILKSCREEN-TOP.gbr
- Bottom Silkscreen: _SILKSCREEN-BOTTOM.gbr
- Drills NPTH: _DRILLS-NPTH.drl
- Drills PTH: _DRILLS-PTH.drl
- Merge PTH and NPTH drills into one file: _DRILLS.drl
- Drills Blind/Buried: _DRILLS-PLATED-{{START_LAYER}}-{{END_LAYER}}.drl
- Use drilled slot command in Excellon files (G85)
- Top Solder Paste (Top Stencil): _SOLDERPASTE-TOP.gbr
- Bottom Solder Paste (Bottom Stencil): _SOLDERPASTE-BOTTOM.gbr

Boards: All, Default, Custom. A list box contains 'default'.

At the bottom, there is a 'Messages' button with a warning icon, and 'Cancel' and 'OK' buttons.

Name

See [Common Configuration Options](#).

Base Path

Specifies the common output path prefix to be used for all the output files. So the actual output file paths consist of this path appended by the corresponding output file suffix as explained below. See also the *Output* option documented in [Common Configuration Options](#).

Outlines

Output file suffix for the board outlines. Will contain all objects on the *Board Outlines* and *Board Cutouts* layers.

Top/Bottom Copper

Output file suffix for the *Top Copper* resp. *Bottom Copper* layers.

Inner Copper

Output file suffix for the *Inner Copper* layers. For each used inner layer, a separate Gerber file is created. Therefore the placeholder `{{CU_Layer}}` needs to be used, which is substituted by the inner layer number ("1" for the first inner layer, just below *Top Copper*).

Top/Bottom Stopmask

Output file suffix for the *Top Stop Mask* resp. *Bottom Stop Mask* layers.

Top/Bottom Silkscreen

Output file suffix for the top resp. bottom silkscreen layers as configured in the board setup dialog. Note that these files are only generated when enabled in the board setup dialog.

Drills NPTH

Output file suffix for the non-plated through-hole Excellon drill file, i.e. all drills which are called *Hole* in LibrePCB (including slotted holes).

Drills PTH

Output file suffix for the plated through-hole Excellon drill file, i.e. all through-hole pads and through-hole vias (including slotted pads).

Merge PTH and NPTH drills into one file

If this option is enabled, all through-hole drills are exported into a single Excellon drill file (with the suffix provided next to this option) instead of generating separate files. So the *Drills NPTH* and *Drills PTH* files won't be created if this option is checked. Note that generally this option is not recommended, but some PCB manufacturers (especially cheap ones) are not able to handle separate files for PTH and NPTH. In that case, this option needs to be enabled.

Drills Blind/Buried

If blind/buried vias are used in the board, a separate Excellon drill file will be created for each different drill layer pair. This option specifies the file name suffix for these files. Since multiple files might be created, the placeholders `{{START_LAYER}}` and `{{END_LAYER}}` need to be used, which will be substituted by either "TOP", "BOTTOM" or "INx" where "x" is the inner layer number starting at 1. Or alternatively, the placeholders `{{START_NUMBER}}` and `{{END_NUMBER}}` are

also available which are substituted by just a number (1 = top layer, 2 = first inner layer etc.).

Use drilled slot command in Excellon files (G85)

If your board contains slots (plated or non-plated), they are exported to Gerber files with G00..G03 commands by default. By checking this option, the G85 slot command will be used instead. This is generally not recommended, but some PCB manufacturers may not support the G00..G03 commands. In that case, the G85 command might need to be used instead.

Top/Bottom Solder Paste

Output file suffix for the *Top Solder Paste* resp. *Bottom Solder Paste* layers. These files are not directly used for the PCB production, but for the SMD stencil to apply solder paste on the PCB. If you don't need a stencil, the generation of these files should be disabled by unchecking the corresponding checkboxes.

Boards

See [Common Configuration Options](#).

Pick&Place CSV

Generates a pick&place position file containing the coordinates of each device on the PCB as comma-separated values (CSV). This file is needed for automatic PCB assembly by pick&place machines. Alternatively, the Gerber X3 format might be used instead, which is provided by the output job type [Pick&Place Gerber X3](#).

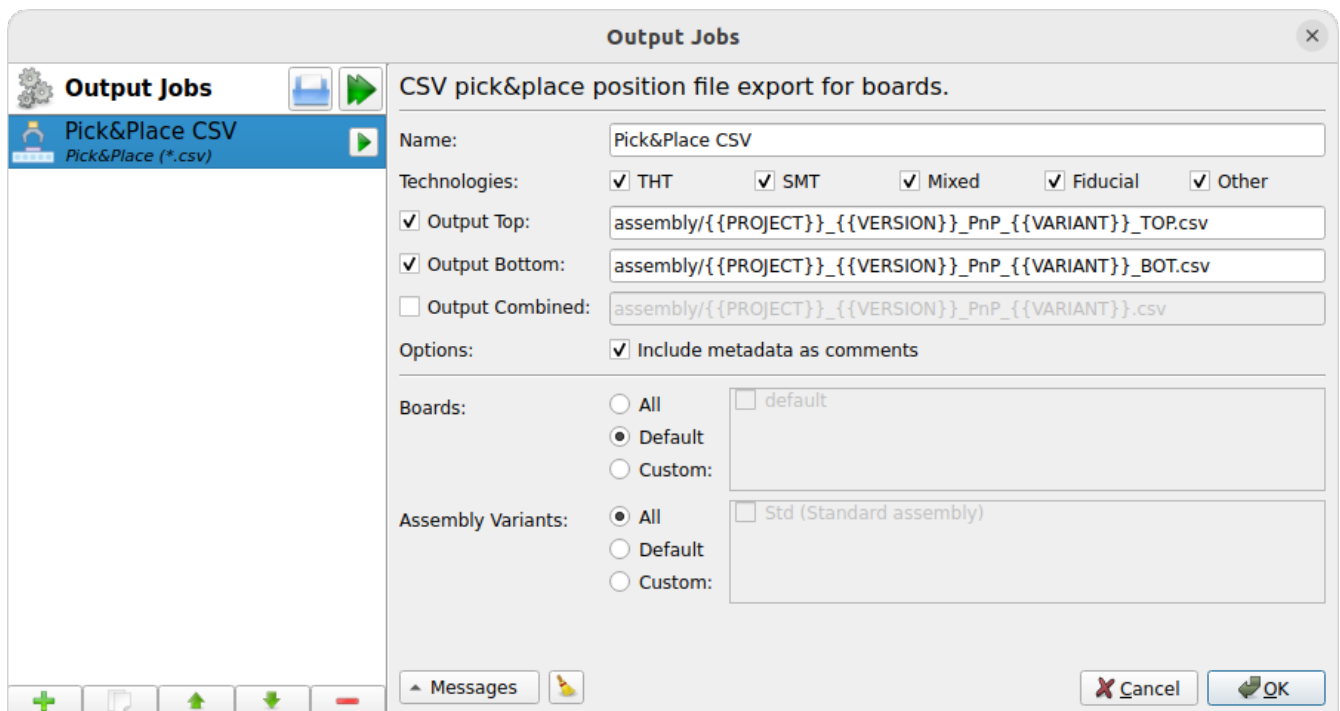

Name

See [Common Configuration Options](#).

Technologies

Selection of device types to be included in the output file. For example if only "THT" is selected, you'll get a CSV file containing only THT devices. The available technologies are:

- **THT:** Pure through-hole devices, i.e. all leads are THT.
- **SMT:** Pure surface-mount devices, i.e. all leads are SMT.
- **Mixed:** Devices containing both through-hole and surface-mount loads (for example SMT connectors with THT pads for mechanical stability).
- **Fiducial:** Whether fiducial coordinates (for PCB alignment) should be contained in the pick&place file or not.
- **Other:** Any other special device types, for example pure mechanical devices to be mounted with screws instead of soldering.

Output Top/Bottom/Combined

See [Common Configuration Options](#). Three different output paths can be configured to get either separate files for top/bottom devices, or a single file for all devices. Must have file extension **.csv**.

Use the checkboxes to select the files to generate.

Include metadata as comments

If checked, the output CSV files will contain a header comment with some metadata like project name, generation date etc. This is helpful for traceability/documentation purposes, but some CSV readers fail to ignore this comment. If you're unsure, just uncheck this option as this is always safe.

Boards

See [Common Configuration Options](#).

Assembly Variants

See [Common Configuration Options](#).

Pick&Place Gerber X3

Same as [Pick&Place CSV](#), but generating Gerber X3 pick&place files instead of CSV files. The advantage of this format is that it's standardized, while there's no standard for CSV pick&place files so CSV might cause issues or at least involves manual effort during pick&place machine setup. However, Gerber X3 is not as widely supported by assembly houses as CSV files.

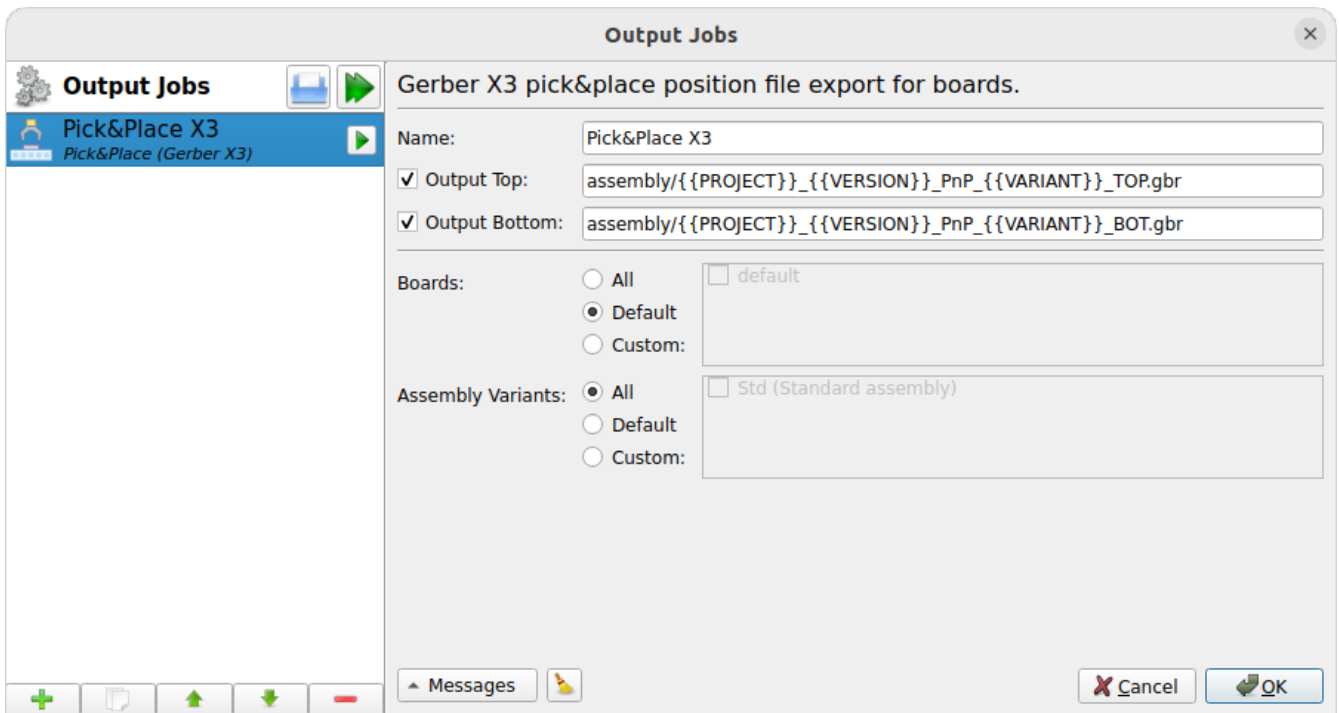

Name

See [Common Configuration Options](#).

Output Top/Bottom

See [Common Configuration Options](#). Two different output paths can be configured to get separate files for top/bottom devices. Should have file extension **.gbr**.

Use the checkboxes to select the files to generate.

Boards

See [Common Configuration Options](#).

Assembly Variants

See [Common Configuration Options](#).

Netlist

Generates an IPC D-356A netlist used for automatic electrical testing of the PCB.

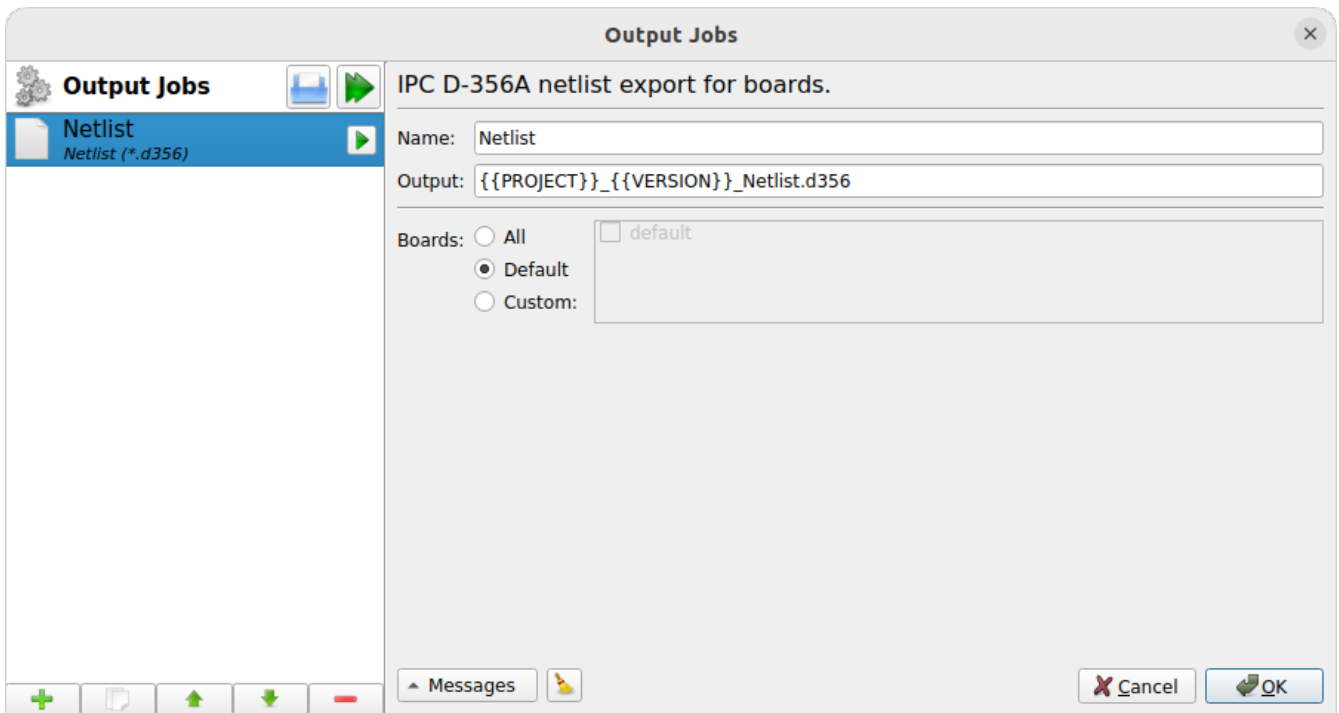

Name

See [Common Configuration Options](#).

Output

See [Common Configuration Options](#). Must have file extension **.d356**.

Boards

See [Common Configuration Options](#).

Bill Of Materials

Generates a bill of materials (BOM) in CSV format, containing all devices to be ordered for a particular assembly variant.

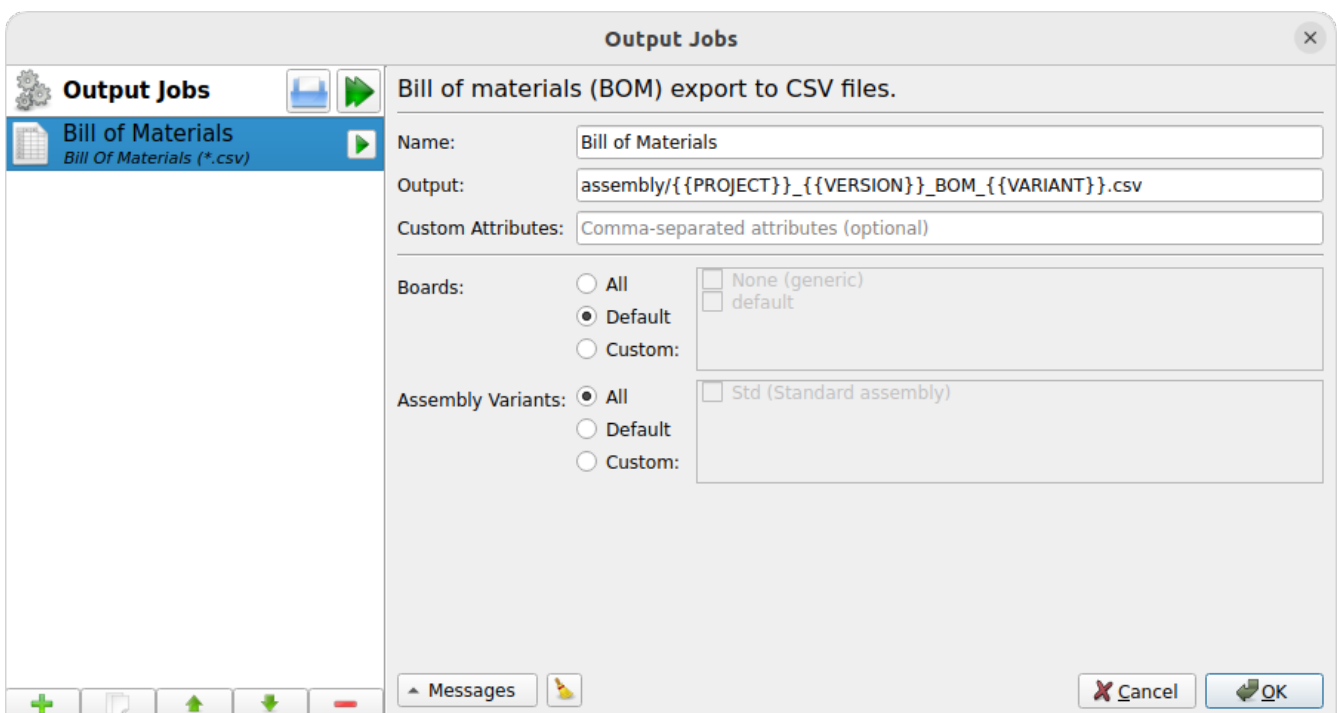

Name

See [Common Configuration Options](#).

Output

See [Common Configuration Options](#). Must have file extension `.csv`.

Custom Attributes

This option allows to add custom additional columns to the output CSV file. For this purpose, attributes are used. For example the value "DIGIKEY,MOUSER" adds the two columns "DIGIKEY" and "MOUSER" to the CSV, with the corresponding values of these attributes on devices. The value will be empty for devices not providing a particular attribute.



When adding the suffix `[]` to a custom attribute, it is considered as a **per-part** attribute instead of a **global** attribute. This means the attribute is not exported to the BOM only once, but once per part of a component. This might be desired if some components have alternative (i.e. multiple) part numbers specified. See [Assembly Data](#) for details.

Boards

See [Common Configuration Options](#).

Assembly Variants

See [Common Configuration Options](#).

The actual number of columns in the output file depends on whether (and how many) alternative part numbers are specified on components. The component with the most part numbers defines how many columns the BOM CSV will have. See [Assembly Data](#) for details.

The order and name of columns is as follows:

- Quantity
- Designators
- Package
- Custom global attribute columns (optional, see above)
- *For each part (minimum 1):*
 - Value
 - MPN
 - Manufacturer
 - Custom per-part attribute columns (optional, see above)



For the typical use-case (without custom attributes and no alternative part numbers specified in schematics), the CSV header looks as following:

Quantity,Designators,Package,Value,MPN,Manufacturer

If at least one component has specified one alternative part number, three additional columns will appear:

Quantity,Designators,Package,Value,MPN,Manufacturer,Value[2],MPN[2],Manufacturer[2]

3D Model

Exports a board as a 3D STEP file for importing it in a mechanical CAD (MCAD). Note that in contrast to the built-in 3D viewer, the exported STEP model won't contain details like copper traces, solder resist or silkscreen.

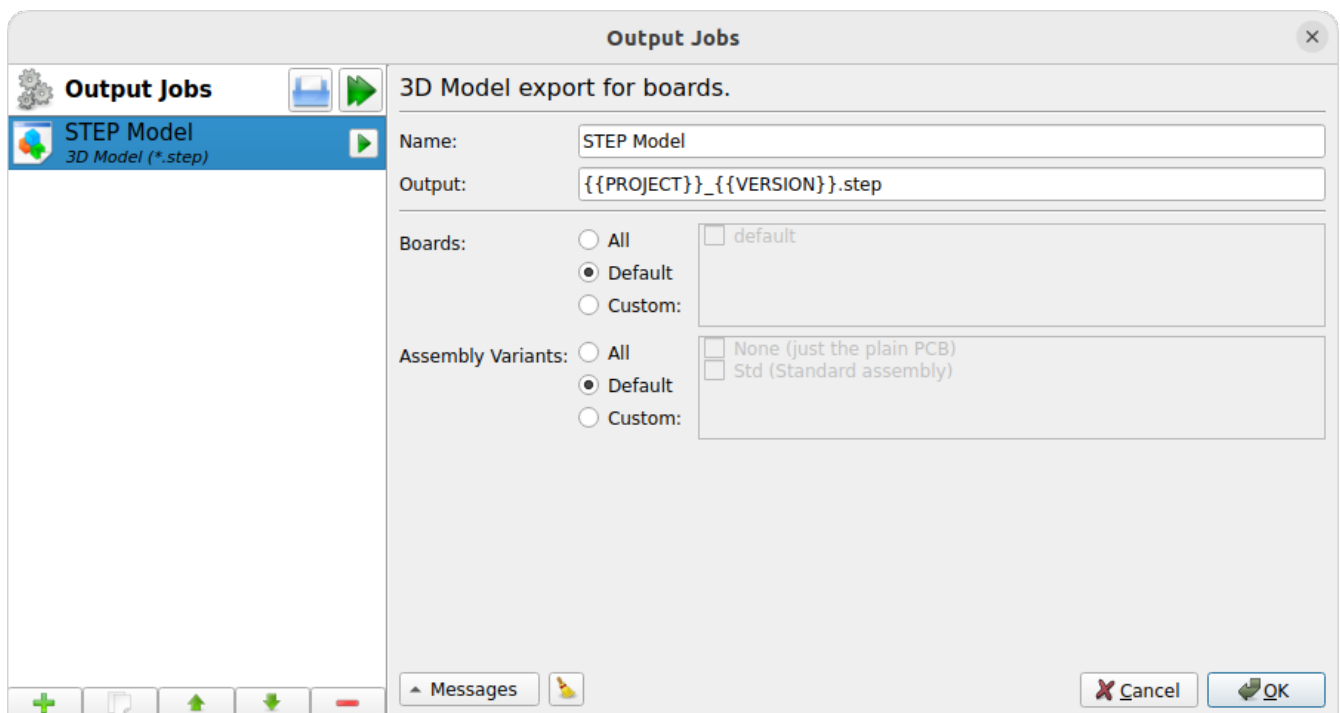

Name

See [Common Configuration Options](#).

Output

See [Common Configuration Options](#). Must have file extension `.step` or `.stp`.

Boards

See [Common Configuration Options](#).

Assembly Variants

See [Common Configuration Options](#). Only devices contained in the corresponding assembly variant will be exported. The special value "None" means that only the plain PCB is exported, without any devices on it.

File Copy

Special job which actually doesn't *generate* anything, but *copies* an existing file into the output directory. This is intended for example to include custom files like instruction notes in the data to be sent to the PCB manufacturer or assembly house.

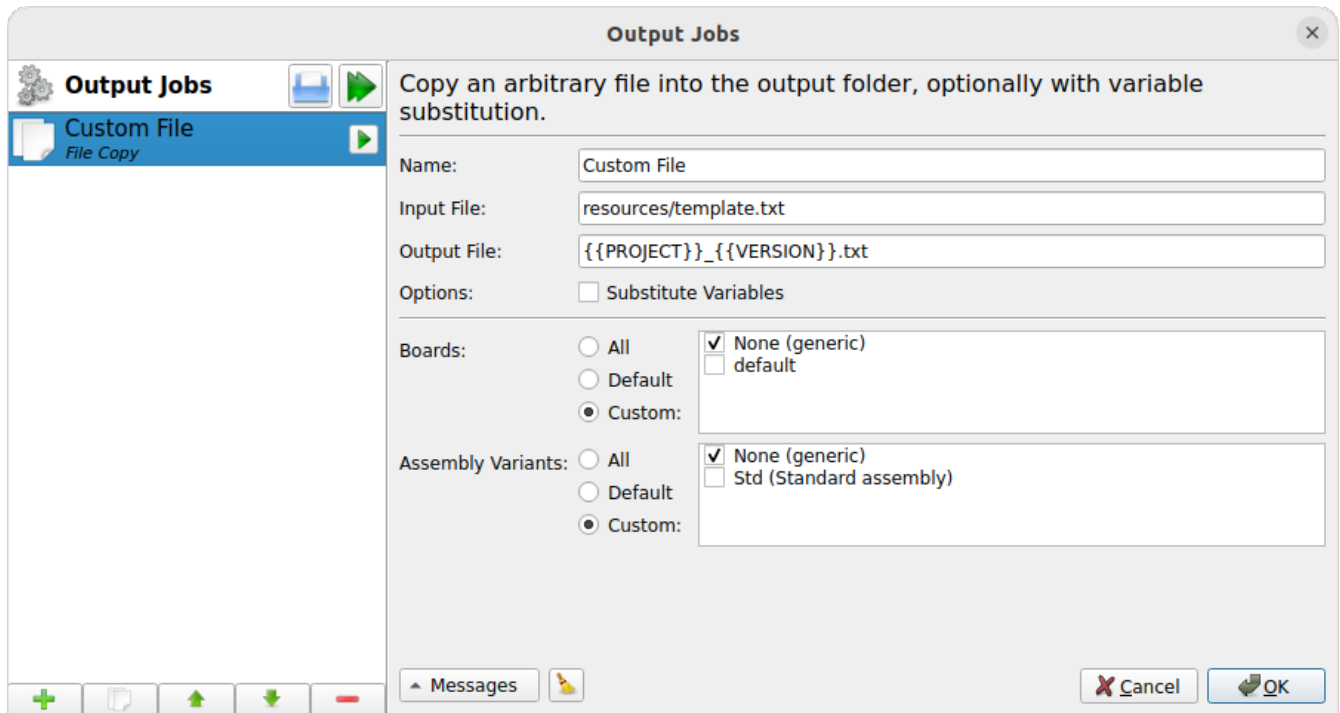

Name

See [Common Configuration Options](#).

Input File

Path to the (existing) input file to copy, relative to the project's root directory. It's highly recommended to place this file within the `resources/` directory (at least do not place it in the `output/` directory!).

Output File

See *Output* in [Common Configuration Options](#). Should have the same file extension as the input file.

Substitute Variables

If checked, the input file is read by LibrePCB and any occurrences of attribute placeholders like `{{PROJECT}}`, `{{VERSION}}` or `{{DATE}}` will be substituted by their value before writing that content to the output destination. Project attributes are always available, while board attributes and assembly variant attributes are only available if the job is run in the context of a board resp. assembly variant (see options below).



That this option shall only be used on text files, not on binary input files.

Boards

See [Common Configuration Options](#). The special value "None" means that this job does not run in the context of a board and will be run exactly once, no matter how many boards the project

contains.

Assembly Variants

See [Common Configuration Options](#). The special value "None" means that this job does not run in the context of an assembly variant and will be run exactly once, no matter how many assembly variants the project contains.

Archive

Special output job which combines the output of other jobs in a single archive file (e.g. ZIP).

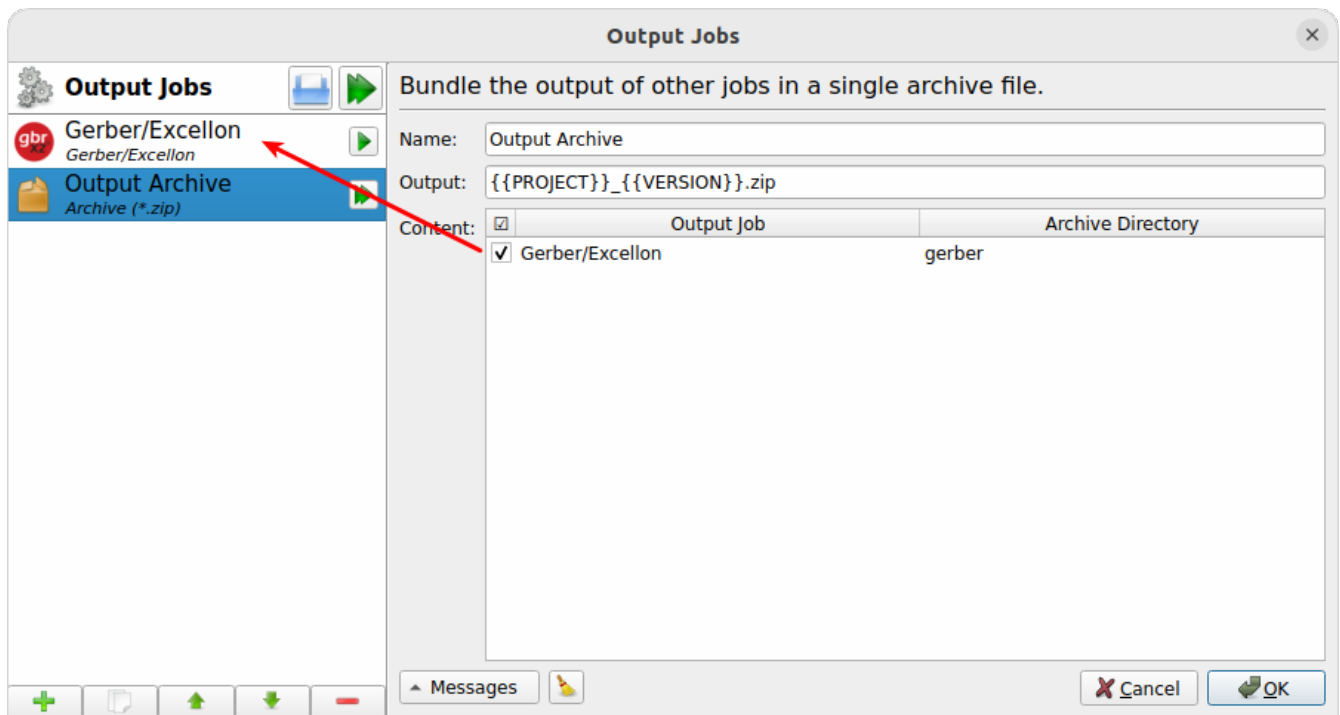

Name

See [Common Configuration Options](#).

Output

See [Common Configuration Options](#). The file extension specifies the type of archive to create. Currently only `.zip` is supported.

Content

Selection of jobs which output files shall be added to the archive. Note that only jobs listed **prior** to the archive job may be selected to ensure no cyclic dependencies can be created (an error will be raised when violating this rule).

All output files of the selected jobs are added to the root directory of the archive, with their original file name but with any subdirectory stripped. It's not possible to specify different file names just for the archive. However, the *Archive Directory* column allows to move all files of a particular job into a custom subdirectory (for example to move all Gerber files into a `gerber/` directory and all pick&place files into `assembly/`).



When running an archive job, LibrePCB will automatically run all its dependent jobs first to generate their output.

Project Data

Generates a custom JSON file containing some metadata about the project. This is not intended for end users but it's still listed publicly for completeness.

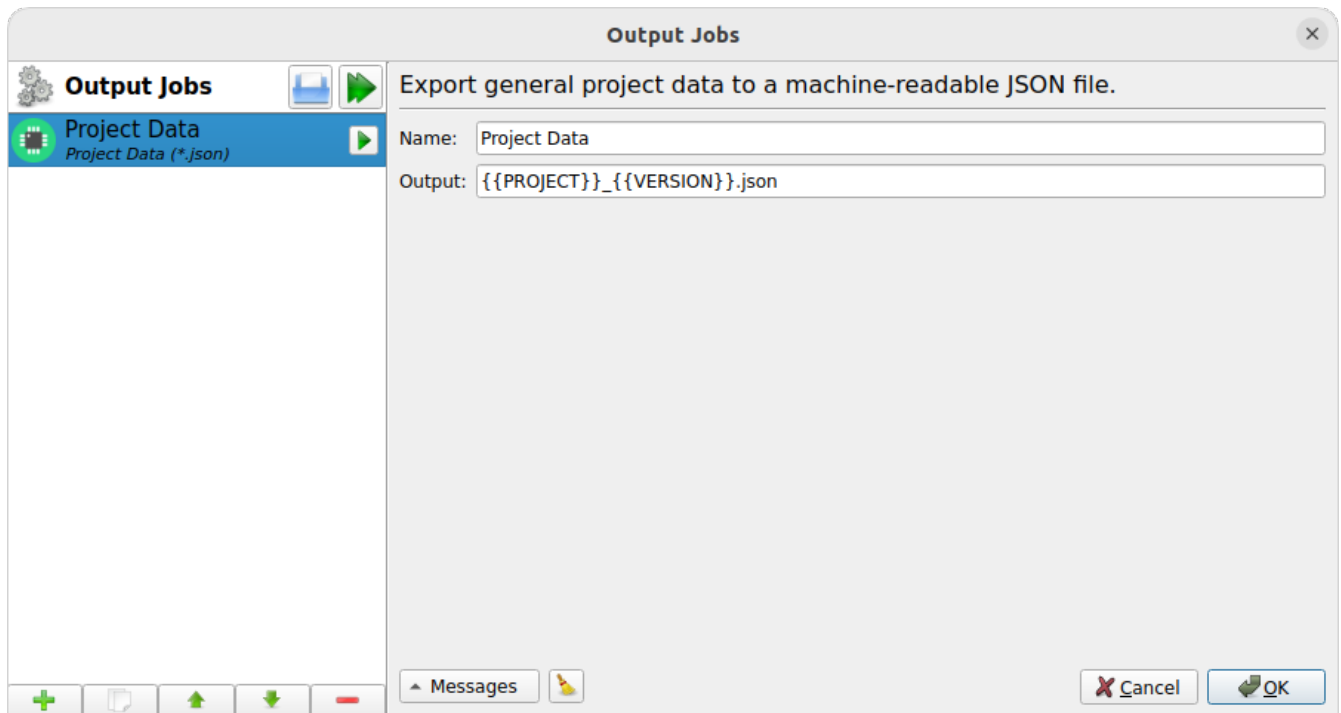

Name

See [Common Configuration Options](#).

Output

See [Common Configuration Options](#). Should have file extension `.json`.

Project Archive

Exports the whole project to a single `*.lppz` file (which is simply a ZIP). Intended to keep a snapshot of a particular project version which can directly be opened with LibrePCB from the desktop file manager. In addition, this file could be uploaded to fab.librepcb.org to (re-)order the PCB.

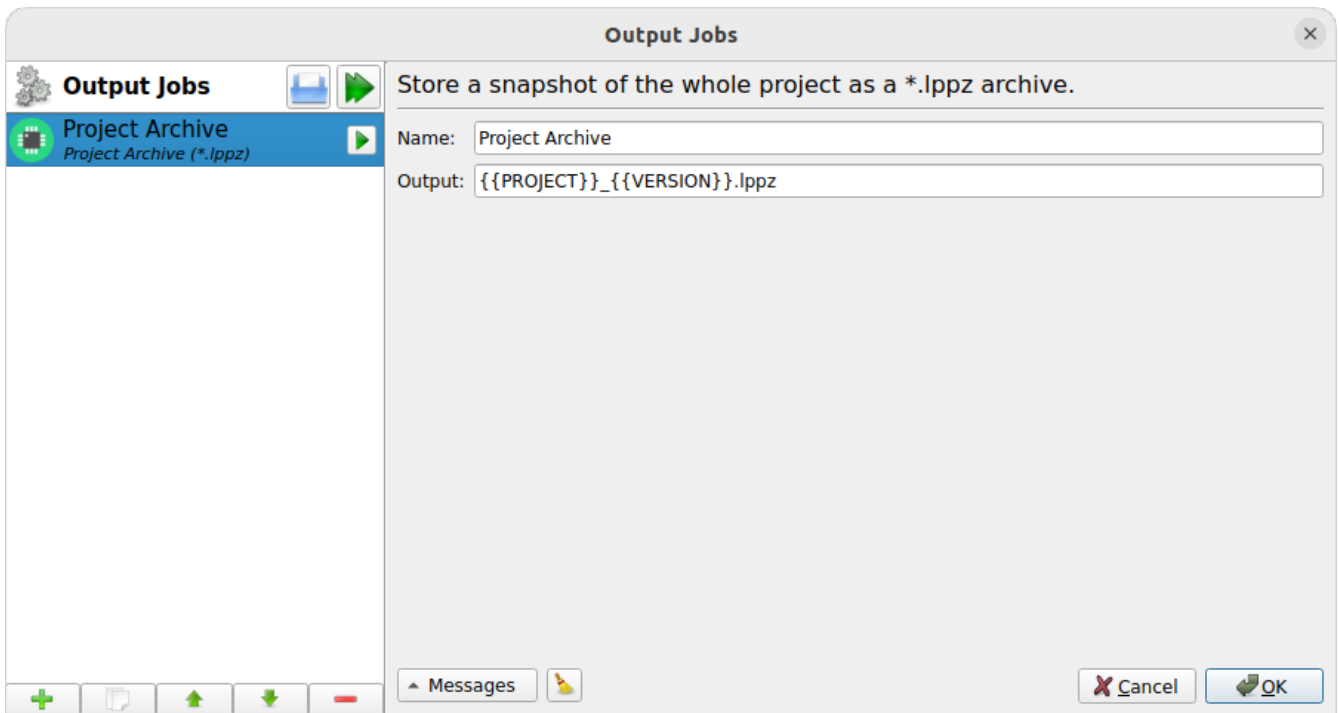

Name

See [Common Configuration Options](#).

Output

See [Common Configuration Options](#). Must have file extension **.lppz**.

[1] Manufacturer part numbers

[2] Bill of materials

Command-Line Interface

LibrePCB also provides a command line interface (CLI). With that tool, you can automate some tasks, for example on Continuous Integration (CI) systems.

Running On Headless Linux

Please note that (at this time) `librepcb-cli` requires a running X-server even if it doesn't open any windows. If your system doesn't have an X-server running, you can use `xvfb` instead:



```
xvfb-run -a librepcb-cli [args]
```

If the `librepcb-cli` executable still doesn't work, you may need to install some dependencies. On Debian/Ubuntu, following packages need to be installed:

```
apt-get install libfontconfig1 libgl1-mesa-glx libglu1-mesa
```

Installation

Binary Releases

Our official LibrePCB [binary releases](#) contain the `librepcb-cli` executable next to the GUI application, so usually no separate installation is needed. But there are two exceptions: The AppImage and the macOS bundle.

Linux AppImage

Download [librepcb-cli-1.0.0-linux-x86_64.AppImage](#), make it executable and run it:

```
wget "https://download.librepcb.org/releases/1.0.0/librepcb-cli-1.0.0-linux-x86_64.AppImage"
chmod +x ./librepcb-cli-1.0.0-linux-x86_64.AppImage
./librepcb-cli-1.0.0-linux-x86_64.AppImage
```

macOS Bundle

Download the portable `*.dmg` file matching your CPU architecture:

- **Intel (x86_64):** [librepcb-cli-1.0.0-mac-x86_64.dmg](#)
- **Apple Silicon (arm64):** [librepcb-cli-1.0.0-mac-arm64.dmg](#)

Double-click the downloaded file in Finder. Then drag and drop the app onto the "Applications" folder in Finder.

Docker Image

The easiest way to get the LibrePCB CLI on Linux (especially for usage on CI) is to pull our official Docker image [librepcb/librepcb-cli](https://github.com/librepcb/librepcb-cli):

```
docker run -it --rm -v `pwd`:/work -u `id -u`:`id -g` \  
  librepcb/librepcb-cli:1.0.0 --help
```

Show Help Text

Usage instructions and available options can be shown with `--help`:

Command

```
./librepcb-cli --help
```

Output

```
Usage: ./librepcb-cli [options] command  
LibrePCB Command Line Interface
```

Options:

```
-h, --help      Print this message.  
-V, --version   Displays version information.  
-v, --verbose   Verbose output.
```

Arguments:

```
command        The command to execute (see list below).
```

Commands:

```
open-library   Open a library to execute library-related tasks.  
open-project   Open a project to execute project-related tasks.  
open-step      Open a STEP model to execute STEP-related tasks outside of a library.
```

List command-specific options:

```
./librepcb-cli <command> --help
```

Command "open-library"

This command opens a LibrePCB library and lets you execute some tasks with it.

Command

```
./librepcb-cli open-library --help
```

Output

```
Usage: ./librepcb-cli [options] open-library [command_options] library
LibrePCB Command Line Interface
```

Options:

```
-h, --help      Print this message.
-V, --version   Displays version information.
-v, --verbose   Verbose output.
--all           Perform the selected action(s) on all elements contained in
                the opened library.
--check         Run the library element check, print all non-approved messages
                and report failure (exit code = 1) if there are non-approved
                messages.
--minify-step   Minify the STEP models of all packages. Only works in
                conjunction with '--all'. Pass '--save' to write the minified
                files to disk.
--save         Save library (and contained elements if '--all' is given)
                before closing them (useful to upgrade file format).
--strict       Fail if the opened files are not strictly canonical, i.e.
                there would be changes when saving the library elements.
```

Arguments:

```
open-library   Open a library to execute library-related tasks.
library        Path to library directory (*.lplib).
```

Examples

Check Library Elements and Upgrade File Format

This command is useful for Continuous Integration of LibrePCB libraries because it reports failure if you check in libraries with invalid or non-canonical S-Expression files or STEP models. In addition, the library check is run (**--check**) and reports failure if there are any non-approved messages.

Command

```
./librepcb-cli open-library --all --check --minify-step --strict MyLibrary.lplib
```

Output

```
Open library 'MyLibrary.lplib'...
Process 86 component categories...
Process 44 package categories...
Process 37 symbols...
Process 492 packages...
Process 34 components...
Process 37 devices...
```

Command "open-project"

This command opens a LibrePCB project and lets you execute some tasks with it.

Command

```
./librepcb-cli open-project --help
```

Output

```
Usage: ./librepcb-cli [options] open-project [command_options] project
LibrePCB Command Line Interface
```

Options:

<code>-h, --help</code>	Print this message.
<code>-V, --version</code>	Displays version information.
<code>-v, --verbose</code>	Verbose output.
<code>--erc</code>	Run the electrical rule check, print all non-approved warnings/errors and report failure (exit code = 1) if there are non-approved messages.
<code>--drc</code>	Run the design rule check, print all non-approved warnings/errors and report failure (exit code = 1) if there are non-approved messages.
<code>--drc-settings <file></code>	Override DRC settings by providing a *.lp file containing custom settings. If not set, the settings from the boards will be used instead.
<code>--run-job <name></code>	Run a particular output job. Can be given multiple times to run multiple jobs.
<code>--run-jobs</code>	Run all existing output jobs.
<code>--jobs <file></code>	Override output jobs with a *.lp file containing custom jobs. If not set, the jobs from the project will be used instead.
<code>--outdir <path></code>	Override the output base directory of jobs. If not set, the standard output directory from the project is used.
<code>--export-schematics <file></code>	Export schematics to given file(s). Existing files will be overwritten. Supported file extensions: pdf, svg, bmp, cur, ico, jpeg, jpg, pbm, pgm, png, ppm, xbm, xpm
<code>--export-bom <file></code>	Export generic BOM to given file(s). Existing files will be overwritten. Supported file extensions: csv
<code>--export-board-bom <file></code>	Export board-specific BOM to given

<code>--bom-attributes <attributes></code>	file(s). Existing files will be overwritten. Supported file extensions: csv Comma-separated list of additional attributes to be exported to the BOM. Example: "SUPPLIER, SKU"
<code>--export-pcb-fabrication-data</code>	Export PCB fabrication data (Gerber/Excellon) according the fabrication output settings of boards. Existing files will be overwritten.
<code>--pcb-fabrication-settings <file></code>	Override PCB fabrication output settings by providing a *.lp file containing custom settings. If not set, the settings from the boards will be used instead.
<code>--export-pnp-top <file></code>	Export pick&place file for automated assembly of the top board side. Existing files will be overwritten. Supported file extensions: csv, gbr
<code>--export-pnp-bottom <file></code>	Export pick&place file for automated assembly of the bottom board side. Existing files will be overwritten. Supported file extensions: csv, gbr
<code>--export-netlist <file></code>	Export netlist file for automated PCB testing. Existing files will be overwritten. Supported file extensions: d356
<code>--board <name></code>	The name of the board(s) to export. Can be given multiple times. If not set, all boards are exported.
<code>--board-index <index></code>	Same as '--board', but allows to specify boards by index instead of by name.
<code>--remove-other-boards</code>	Remove all boards not specified with '--board[-index]' from the project before executing all the other actions. If '--board[-index]' is not passed, all boards will be removed. Pass '--save' to save the modified project to disk.
<code>--variant <name></code>	The name of the assembly variant(s) to export. Can be given multiple times. If not set, all assembly variants are exported.
<code>--variant-index <index></code>	Same as '--variant', but allows to specify assembly variants by index instead of by name.
<code>--set-default-variant <name></code>	Move the specified assembly variant to the top before executing all the other actions. Pass '--save' to save the modified project to disk.
<code>--save</code>	Save project before closing it (useful to upgrade file format).
<code>--strict</code>	Fail if the project files are not strictly canonical, i.e. there would be changes when saving the project. Note that this option

is not available for *.lppz files.

Arguments:

open-project

Open a project to execute project-related tasks.

project

Path to project file (*.lpp[z]).

Examples

Run ERC, DRC and Output Jobs

This command is useful for Continuous Integration of LibrePCB projects because it reports failure if you check in projects with non-approved ERC or DRC messages. In addition, it generates all production data files of the configured output jobs so you don't have to do it manually.

Command

```
./librepcb-cli open-project --erc --drc --run-jobs MyProject.lpp
```

Output

```
Open project 'MyProject.lpp'...
Run ERC...
  Approved messages: 7
  Non-approved messages: 2
    - [WARNING] Net signal connected to less than two pins: "CAN_RX"
    - [WARNING] Net signal connected to less than two pins: "JTCK"
Run DRC...
  Board 'default':
    Approved messages: 0
    Non-approved messages: 5
      - [ERROR] Clearance copper ⌀ hole < 0.25 mm
      - [ERROR] Clearance copper ⌀ hole < 0.25 mm
      - [ERROR] Clearance drill ⌀ drill < 0.35 mm
      - [ERROR] Clearance plane ⌀ board outline < 0.3 mm
      - [ERROR] Clearance plane ⌀ board outline < 0.3 mm
Run output job 'Schematic PDF'...
  => 'output/v1/MyProject_v1_Schematic.pdf'
Run output job 'Gerber/Excellon'...
  => 'output/v1/gerber/MyProject_v1_DRILLS-NPTH.dr1'
  => 'output/v1/gerber/MyProject_v1_DRILLS-PTH.dr1'
  => 'output/v1/gerber/MyProject_v1_OUTLINES.gbr'
  => 'output/v1/gerber/MyProject_v1_COPPER-TOP.gbr'
  => 'output/v1/gerber/MyProject_v1_COPPER-BOTTOM.gbr'
  => 'output/v1/gerber/MyProject_v1_SOLDERMASK-TOP.gbr'
  => 'output/v1/gerber/MyProject_v1_SOLDERMASK-BOTTOM.gbr'
  => 'output/v1/gerber/MyProject_v1_SILKSCREEN-TOP.gbr'
  => 'output/v1/gerber/MyProject_v1_SILKSCREEN-BOTTOM.gbr'
  => 'output/v1/gerber/MyProject_v1_SOLDERPASTE-TOP.gbr'
```



```
=> 'output/v1/gerber/MyProject_v1_SOLDERPASTE-BOTTOM.gbr'  
Finished with errors!
```

In this example, the application reported errors and exited with code **1** because there are non-approved ERC/DRC messages.

Library Conventions

Here we collect conventions / guidelines to be used when designing libraries.



These guidelines are not yet complete. Help us create sensible conventions [on GitHub!](#)

Symbol Conventions



These guidelines are not yet complete. Help us create sensible conventions [on GitHub!](#)

Generic vs. Specific

Generic components should have generic symbols. For example a diode (let's say *1N4007*) doesn't need its own symbol, a generic diode symbol is fine. So you should name it something like "Diode" and use the same symbol also for all other standard diodes. Of course every kind of diode (e.g. Zener) should have its own symbol because they look different.

On the other side, there are many very specific components, for example a microcontroller. Even if it's possible to also use generic symbols for them (e.g. "32-Pin IC"), you should create a symbol specific for that part instead. This way you can choose a reasonable [pin placement](#).

Naming

Following conventions apply to symbol names:

- Language must be American English (en_US)
- Title case (e.g. "Capacitor Bipolar" instead of "Capacitor bipolar")
- Singular names, not plural (e.g. "Diode" instead of "Diodes")
- If reasonable, start with the generic term (e.g. "Supply GND" instead of "GND Supply") to improve navigation in sorted lists (all supply symbols are listed next to each other)

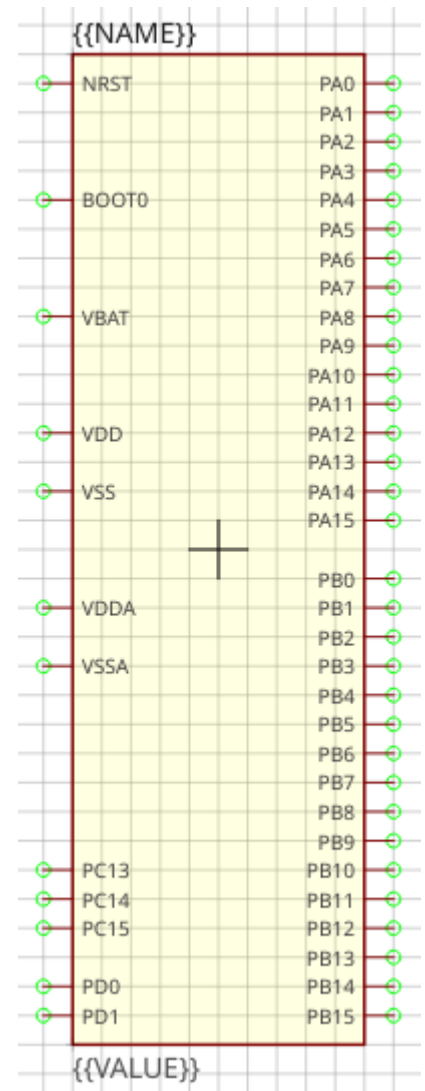

Origin

The origin $(0, 0)$ must be at the center of the symbol (not including text elements). For non-symmetrical symbols it should be as close as possible to the center, but still on the 2.54mm grid.

Outline

The outline of a regular symbol should be drawn with a rectangle or a polygon. All vertices should be located on the 2.54mm grid and following properties should be used:

- **Layer:** *Outlines*
- **Line Width:** *0.2 mm*
- **Filled:** *no*
- **Grab Area:** *yes*

Special symbols (like a capacitor) might not have a regular outline, in such cases it's allowed to use different properties to draw the symbol geometry.

Pin Placement

- For integrated circuit symbols (i.e. rectangular outline), generally **don't place pins at the top and bottom edges**, but only on the left and the right. This helps to get clear, easily readable schematics.
- **Group pins by functionality**, not by physical location of the leads or by datasheet. Always keep the typical application circuit in mind and choose pin locations which help to get clear schematics with only few crossed-over net lines. For example put *GND* exactly 5.08mm below the *VCC* pin if it's likely that capacitors need to be connected to them (capacitors have a height of 5.08mm). Or place *D+* and *D-* of a USB device right on top of each other (with the default distance of 2.54mm) as they are always used as a pair.
- **Use a pin length of 2.54mm** if possible. Other pin lengths should be used only in special cases.

Pin Naming

If the function of a pin is absolutely clear (e.g. anode/cathode of a diode), choose its abbreviated functionality as name (e.g. "A" for anode and "C" for cathode). If the functionality is not clear in the symbol (because it's defined by the component using that symbol), just use numbers starting with "1" at top left and increment them counterclockwise.

Text Elements

Typical symbols should have exactly two text elements: `{{NAME}}` and `{{VALUE}}`.

For rectangular symbols, the name should be placed at top left, aligned at bottom left to the corner of the symbol outlines. And the value should be placed at bottom left, aligned at the top left to the corner of the symbol outlines.

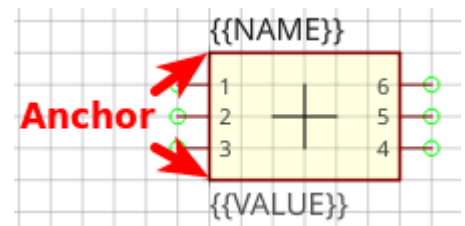

Irregularly shaped symbols may have text elements placed differently, see for example the crystal at the left. Keep in mind that the value of a component can consist of several lines, so there should always be enough space available for it.

Typical text element properties

Property	Name text element	Value text element
Layer	<i>Names</i>	<i>Values</i>
Text	<code>{{NAME}}</code>	<code>{{VALUE}}</code>
Alignment	<i>Bottom Left</i>	<i>Top Left</i>
Height	<i>2.5mm</i>	<i>2.5mm</i>
Rotation	<i>0°</i>	<i>0°</i>

Grab Area

The grab area is the region of a symbol where it can be grabbed with the mouse (to move it, or to open the context menu). Symbols which have a single outline (like an IC) should typically have the "Grab Area" property set on the outline polygon (which makes the area filled with yellow color).

For symbols which have a more complex outline or which do not look nice with the yellow fill you should add an extra polygon to explicitly define the grab area. See the blue area of the push button for example. Ensure that the polygon doesn't overlap with pins and use following polygon properties:

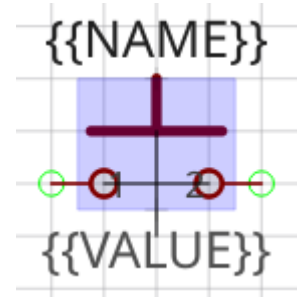

- **Layer:** *Hidden Grab Areas* (will not be visible in the schematic editor)
- **Line Width:** *0.0 mm*
- **Filled:** *yes*
- **Grab Area:** *yes*



The origin cross of a symbol is always also an implicit grab area. So even if there is no explicit grab area defined, the symbol can still be grabbed.

Package Conventions



These guidelines are not yet complete. Help us create sensible conventions [on GitHub!](#)

Scope

The most important thing to consider when creating a package is the scope of it. Since LibrePCB handles footprints differently than other EDA tools, special attention is required here.

Think about the appearance of the part (the mechanical shape, dimension and color). If two parts look exactly (or *almost*) equal, they can use the same package. If they look different, two separate packages must be created.



Don't think about the land pattern (i.e. footprint) of the part — it's not relevant for this decision. Even if a package can be mounted differently on a PCB (e.g. a THT resistor can be mounted horizontally or vertically) and thus require different footprints, only one package is needed. Similarly, two different-looking parts that have the same land pattern (e.g. a SMD resistor and a SMD LED) should still be two separate packages.

Example 2. Color (e.g. 0805 LED)

Even if a 0805 LED with a transparent lens has exactly the same footprint as a 0805 LED with a

red lens, they should have **separate packages because of the different color**. This way a device can link to the package with the proper color, and thus it will appear with the proper color in the 3D PCB preview (once LibrePCB supports 3D models).

Example 3. Height (e.g. SO-8)

Some packages are available in different heights. For instance, SO-8 is available with heights of 1.2mm and 1.4mm. **As the 3D models would be different, separate packages are needed.**

Note: To avoid creating too many packages, a small tolerance is allowed. So for a device with a height of 1.3mm you might want to use the package with a height of 1.4mm.

Example 4. Mounting variants (e.g. TO220)

Many packages can be mounted either vertically or horizontally, for example the TO220. If mounted horizontally, there might be a hole in the PCB to screw the metal tab down to the PCB, or you may want to solder the tab to the PCB without a hole in it. For all these cases **only one package is needed** — the different mounting variants should be handled by different footprint variants inside the package.

Naming

The following conventions apply to package names:

- We generally **follow IPC-7351 when naming packages** (e.g. "SOT23-5P95_280X145L60" instead of "SOT23-5"). Alternative names (like "SOT23-5") should be added to the comma-separated keywords list and maybe to the description.
- For packages not covered by IPC-7351, use following naming conventions:
 - **Language must be American English** (en_US), if applicable (many packages have language-neutral names anyway).
 - **Size information must use metric units**, not imperial units.
 - For packages which are available with different pin counts, **append the pin count with a hyphen as separator and omit leading zeros** (e.g. "DIP-8" instead of "DIP08").
- For packages which are well known by their size in imperial units (e.g. "0805" which is "2012" in metric), it's recommended to write the well known name in parentheses. For example, a chip resistor could be named "RESC2012X70 (0805)".
- The name of manufacturer-specific packages should start with the manufacturers name (e.g. "Molex 53261-06"). *Note: Libraries do not act as namespaces for package names, so you should start the package name with the manufacturers name even if the package is located in a manufacturer-specific library.*

Pads

- **Each lead of the package should be represented by a separate package pad**, even if there

are internal connections (e.g. multiple GND leads) or unconnected leads (e.g. the often unused metal tab of a TO220). Exceptions:

- Multiple mechanical leads which have a package-internal connection (e.g. tabs of the metal housing of an USB connector) should be represented by a single package pad (and all footprint pads connected to it).
 - Leads for pure mechanical purpose without any internal connection at all (e.g. split solder tabs of a plastic connector) shouldn't be added as package pads (the corresponding footprint pads can be left unconnected). If in doubt or if connected to a metal cover of significant size (possibly having a shielding function), treat them like normal, electrically relevant leads.
- **Use pad names according IPC-7351** (if applicable). For packages which are not covered by IPC-7351:
 - If the function of a pad is absolutely clear, choose its abbreviated functionality as name (e.g. "A" for anode and "C" for cathode).
 - Otherwise just use numbers starting with "1" at top left and increment them counterclockwise.

Footprints

Within a package there can be multiple footprint variants. They are intended to support the following use-cases:

- **Mounting variants:** For example, a THT resistor can be mounted either vertically or horizontally with various pad distances. Every common mounting variant should be available as footprint variants.
- **Soldering techniques:** Many packages can be soldered either by reflow-, wave- or hand-soldering, which usually require different land patterns. For every suitable soldering technique there could be a corresponding footprint variant.
- **Density levels:** [IPC-7351](#) specifies three different density levels for footprints:
 - Density Level A: Maximum (Most) Land Protrusion
 - Density Level B: Median (Nominal) Land Protrusion
 - Density Level C: Minimum (Least) Land Protrusion

If applicable, these three density levels should also be added as footprint variants.

Combinations



As a given package might support multiple of the use-cases above, all suitable combinations of them should be added. For example a package which should have all three density levels as defined in IPC-7351 and can be mounted either vertically or horizontally would need six footprint variants to support all possible use-cases.



Set default footprint

The first footprint is always the default footprint, so you should move the most reasonable footprint to the top of the footprint list! The default footprint should

fulfill these rules:

- Generic packages: Designed according to IPC density level B (if applicable)
- Manufacturer-specific packages: Designed according to datasheet
- Suitable for reflow soldering (if applicable)
- Most natural mounting variant (e.g. horizontal for THT resistors, or vertical for Transistor Outline packages)

Example 5. THT resistor 0207 footprint variants

Footprint Variants

Default	Name				
63478879-99c7...	Horizontal 7.62mm				
b5afb23e-e9be...	Horizontal 10.16mm				
3cccaccf-5dc2...	Horizontal 12.7mm				
4b48782b-0e12...	Horizontal 15.24mm				
5658c521-17cd...	Vertical 2.54mm				
2f9b2f9d-2b17...	Vertical 5.08mm				
Add new footprint:					

The diagrams illustrate six different footprint variants for a THT resistor. Each variant shows a resistor body with two leads, labeled with `{{NAME}}` and `{{VALUE}}`. The variants include horizontal and vertical orientations, and different lead lengths and positions.

Origin

The origin (0, 0) should be exactly at the center of the package body. It is used by pick and place machines.

Some packages (especially those with non-symmetrical body) have the origin explicitly specified in the datasheet. In that case, use the origin from the datasheet.

Orientation

Footprints must be drawn from the top-view. When a footprint needs to appear on the bottom of a board, this can be done in the board editor by mirroring it.

Pin 1 should always be at the top left, as defined in [IPC-7351C "Level A", slide 22](#).

Example 6. Footprint orientation examples

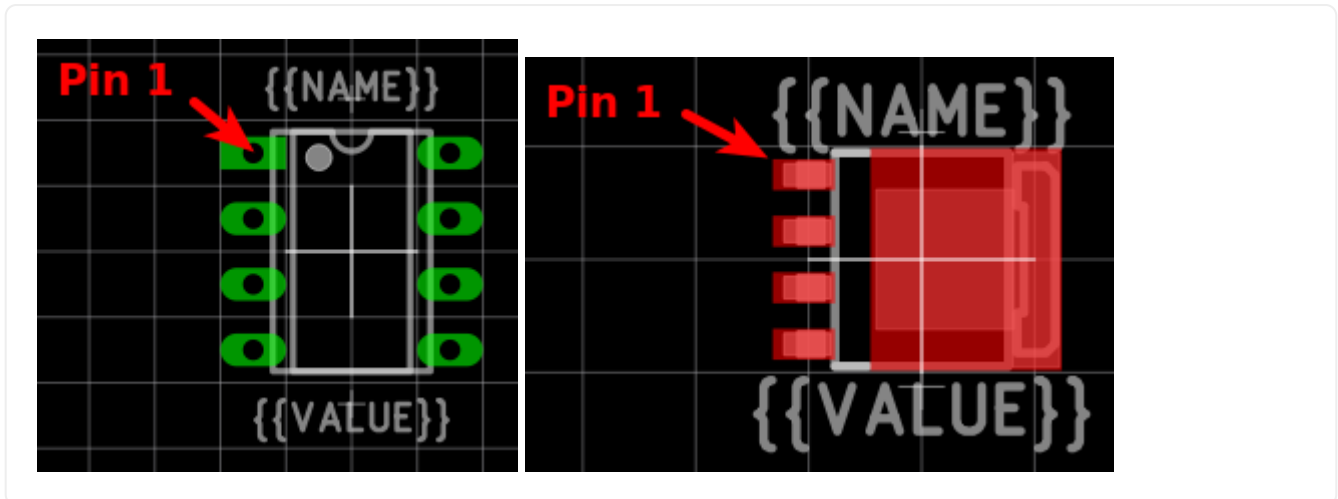

Legend Layer



In LibrePCB 0.1.x, these layers were called *Top/Bottom Placement*. Starting with LibrePCB 1.0, they are now called *Top/Bottom Legend*.

The *Top Legend* layer is intended to be printed on silkscreen and thus should contain information required for assembling the PCB. But don't put too many things on that layer as it would waste space on the PCB!

Typically this layer should only contain some lines and dots to indicate where and in which orientation the device gets assembled, for example an outline and a dot next to pin 1.

The legend should be drawn according to IPC-7351C. The most important rules are the following:

- **It should stay visible after assembling the package** to allow reviewing positioning and orientation of assembled devices. In other words, the legend layer should primarily contain drawings *around* the package's body, but not *under* it.
- **Line width:** 0.2mm typical, 0.1mm minimum
- **Clearance to copper layers:** Equal or greater than the line width, but at least 0.15mm

Example 7. Legend layer examples (only legend and copper layers shown)

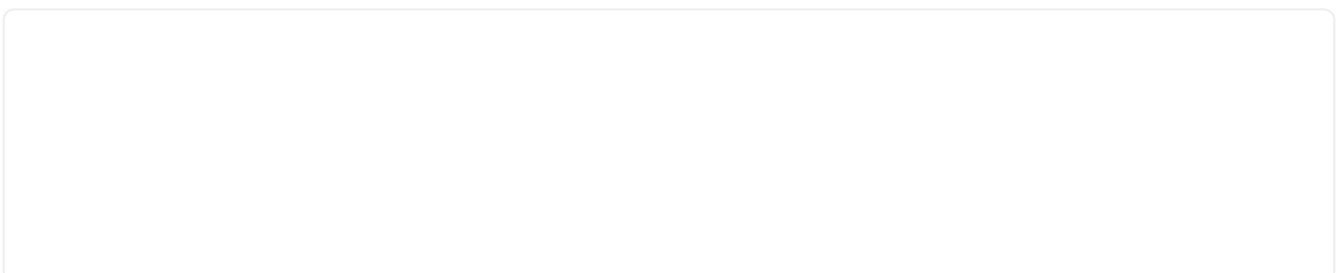

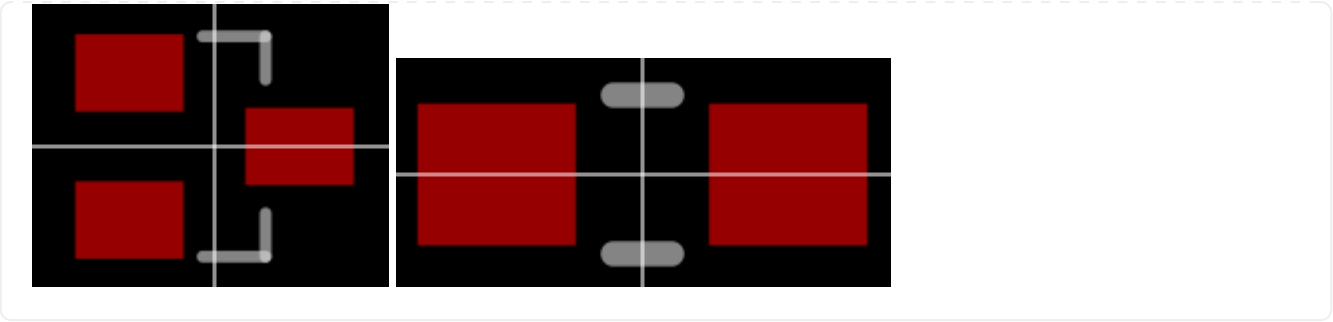

Documentation Layer

The layer *Top Documentation* should be used to draw the most important details of the package's appearance. It could be considered as an alternative to the 3D model of a package. But in contrast to the 3D model, the documentation layer is visible in the board editor while laying out the PCB.

Following things should be placed on the documentation layer:

- **The package's exact outline.** Attention: The **outer** edges of the lines should correspond to the package's edges, **not** the middle of the lines! So, for example if the body is 5x5mm and the line width 0.2mm, you have to draw a 4.8x4.8mm rectangle.
- **The top view of the leads/legs:** The leads or legs of both THT and SMT pads should be drawn from the top view, i.e. the vertical projection of them. This is needed to make packages look realistic on the documentation layer, as leads and legs are an important part of the appearance of packages.
- **The contact area of SMT leads:** The area where SMT leads touch the copper land pattern should be drawn as **filled polygons with a line width of 0mm**. This helps the PCB designer to see the expansion of the land pattern, i.e. how much copper is around the actual lead.

Example 8. Documentation layer examples (only documentation and copper layers shown)

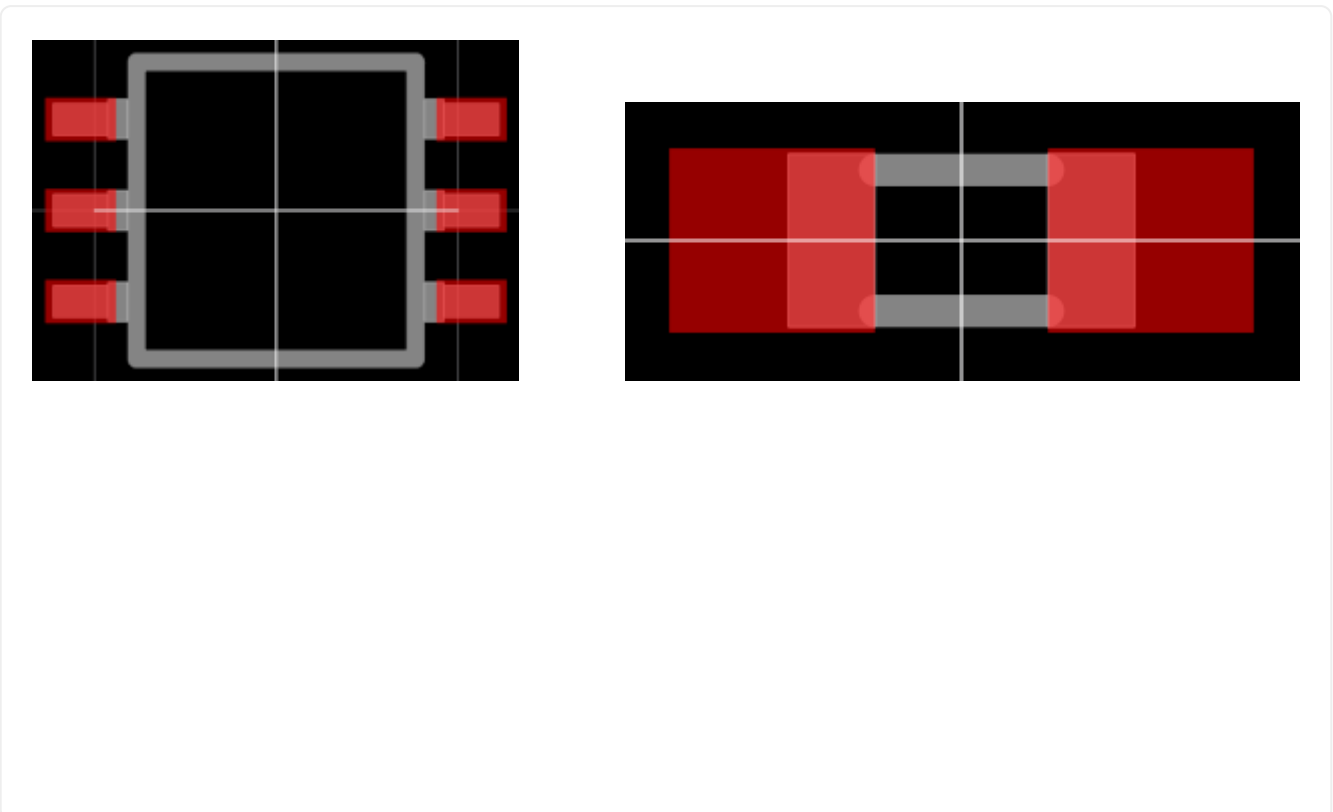

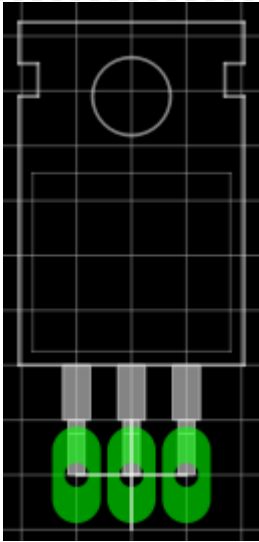

Package Outlines Layer

Every typical footprint should contain a single polygon on the *Top Package Outlines* layer to specify the outer dimension of the package. It is used by the DRC to check the clearance between devices.

General rules:

- **Any leads shall be included**, but pads not.
- **Line width:** 0.0mm

Example 9. Package outlines layer examples (the line in cyan)

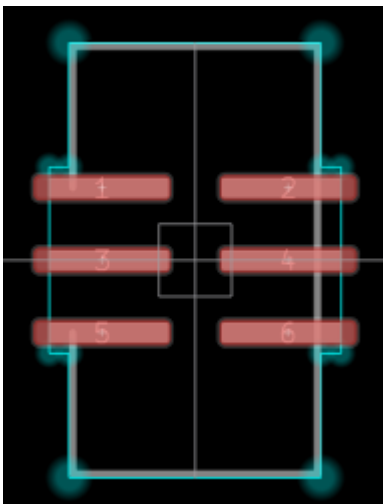

Courtyard Layer

Every typical footprint should contain a single polygon on the *Top Courtyard* layer to specify the area where no other device shall be placed. It is used by the DRC to check this requirement. Usually this is equal to the [Package Outlines Layer](#), just with an offset of several 0.1mm.

General rules:

- **Line width:** 0.0mm
- **Offset to outlines:** According to IPC 7351 if applicable. A typical value for SMT devices is 0.2mm. For THT devices, a larger value (e.g. 0.4mm) is recommended.

Example 10. Courtyard layer examples (the line in magenta)

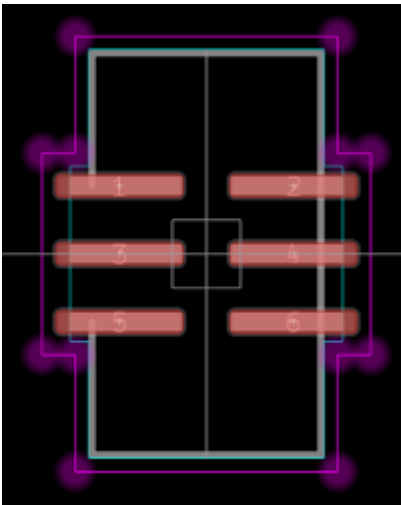

Text Elements

Typical footprints should have exactly two text elements: `{{NAME}}` and `{{VALUE}}`.

The name should normally be placed at top of the package body, slightly above the outline and aligned at bottom center. The value should be placed at the bottom center, slightly below the package body and aligned at the top center.

Always make sure that the text elements do not overlap with pads or with the placement layer. Otherwise the text might be unreadable on silkscreen. In addition, text elements should usually be placed outside the package body to still see them on silkscreen of an assembled PCB.

Keep in mind that the bottom-aligned anchor is placed on the text baseline. This means that some letters like "g" or "y" might extend slightly below the anchor.

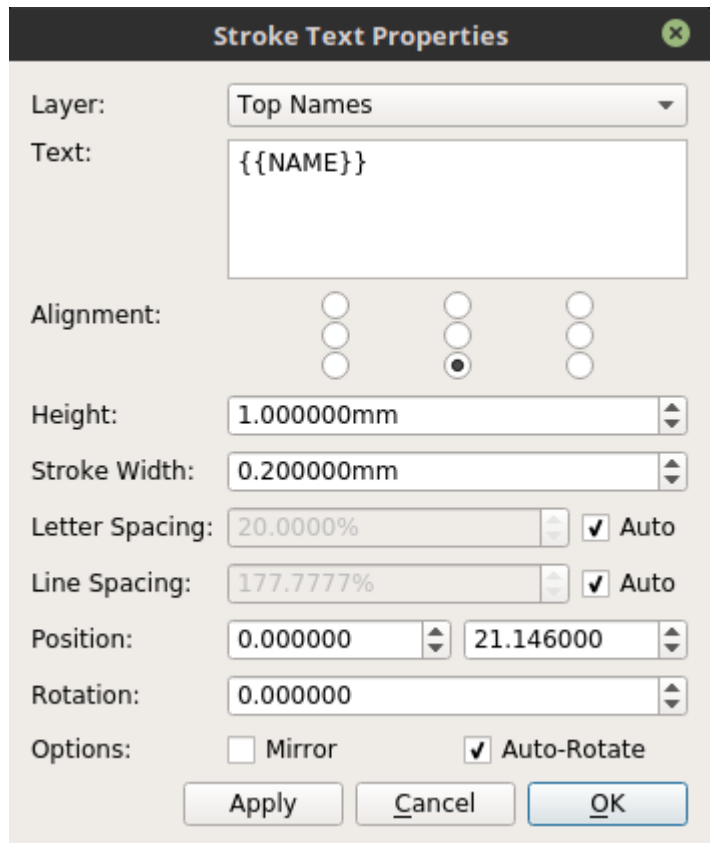

Figure 1. Typical footprint name properties

Typical text element properties

Property	Name text element	Value text element
Layer	<i>Top Names</i>	<i>Top Values</i>
Text	<i>{{NAME}}</i>	<i>{{VALUE}}</i>
Alignment	<i>Bottom Center</i>	<i>Top Center</i>
Height	<i>1.0mm (or larger)</i>	<i>1.0mm (or larger)</i>
Stroke Width	<i>0.2mm (or thicker)</i>	<i>0.2mm (or thicker)</i>
Letter Spacing	<i>Auto</i>	<i>Auto</i>
Line Spacing	<i>Auto</i>	<i>Auto</i>
Mirror	<i>No</i>	<i>No</i>
Auto-Rotate	<i>Yes</i>	<i>Yes</i>



Special cases

These rules should be fine for many packages, but probably not for all of them. For special cases it's allowed to have slightly different properties if they are more suitable.

Example 11. Footprint text element examples

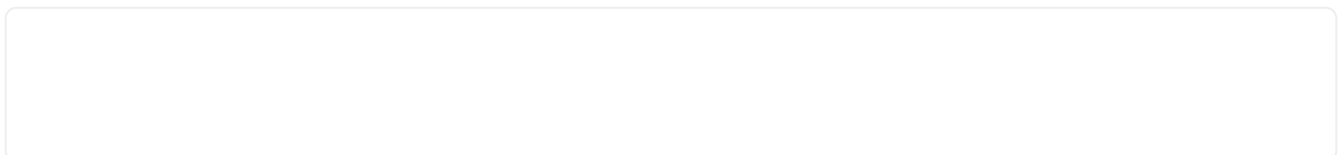

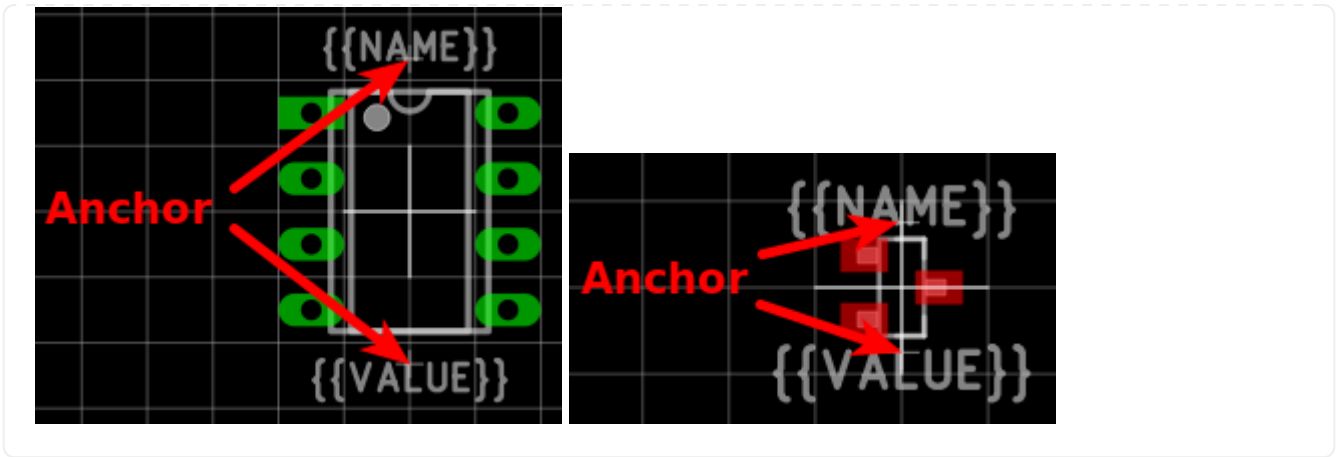

3D Models

Packages might be populated with 3D models from STEP files. However, there are several things to consider carefully.

Some general notes:

- **File size:** Try to keep STEP models as small as possible to avoid unnecessary long download- and loading times. Usually it is fine to keep STEP models rather simple (i.e. not adding too much details).
- **License:** Keep in mind that all libraries provided by LibrePCB are released under the [CC0 Public Domain](#) license. This also applies to STEP models.



Almost every STEP model available in the Internet (whether from a manufacturer or some other website) are not published under the CC0 license and sometimes are also very bloated (way too detailed). Such models must not be contributed to our official libraries (we won't accept them). We may change this requirement some day, but at the moment this needs to be respected.

In addition, we prefer STEP models to be generated with [CadQuery](#) to allow making modifications in future. Contributions of STEP models created in any other way may not be accepted.

Development

For developers of LibrePCB, or if you're interested in technical details of LibrePCB, check out the developers documentation at developers.librepcb.org.